

# BBL STANDS



- PADLOCKS
- CYLINDERS
- PATIO LOCKS
- DOOR LOCKS
- DOOR FITTINGS
- HASP & STAPLES
- ELECTRIC LOCK KITS
- CUPBOARD LOCKS
- DOORVIEWERS
- NIGHT LATCHES
- GARAGE LOCKS
- DEADLOCKS
- KNOBLOCKS
- HASPLOCKS
- SAFE LOCKS
- GATE LOCKS

WITH A VAST RANGE OF PRODUCTS TO CHOOSE FROM YOU CAN PUT TOGETHER A STAND TO MEET THE DEMAND OF YOUR CUSTOMERS.

WE PROVIDE THE STAND AND WILL MERCHANDISE IT ACCORDING TO YOUR SPECIFIC NEEDS OUR ATTRACTIVE PACKAGING WHICH ALLOWS THE CUSTOMER TO VIEW THE PRODUCT AND USEFUL INFORMATION ON THE REVERSE SIDE OF THE PACK INCREASES SALES OF THE PRODUCT THUS BOOSTING THE TURNOVER OF YOUR BUSINESS

# INDEX

Cabinet Locks.....	24
Cash Boxes.....	19
Camlocks.....	26
Cupboard Locks.....	23
Cutters.....	87
Cylinders.....	29
Deed Box.....	19
Digital Locks.....	45
Door Fittings.....	38
Door Closers.....	44
Electric Locks & Accessories.....	62
Fire Box.....	19
Gate Locks ( CISA ).....	55
Gate Locks ( General ).....	15
Garage Locks.....	59
Hasp & Staples.....	37
Key Blanks ( CISA ).....	32
Key Blanks (transponder).....	103
Keycutting Machines.....	90
Key Cabinets.....	19
Knoblocks - Entrance Locksets.....	46
Keytags & Keyrings .....	27
Locksets.....	56
L-Handles.....	61
Lock Boxes.....	18
Locksmith Tools.....	69
Mortice Locks.....	48
Night Latches.....	13
Padlocks.....	1
Patio Locks.....	40
Panic Devices.....	41
Rebate Kits.....	58
Remotes .....	111
Rim Locks .....	57
Safes.....	20
Safe Locks.....	21
Showcase Locks.....	24
Software.....	102
T-Handles.....	60
Transponder.....	97
Utility Blanks.....	83

# PADLOCKS

## BBL Standard Padlocks



BBP940-1



BBP950LS63-1



BBP950LS76-1

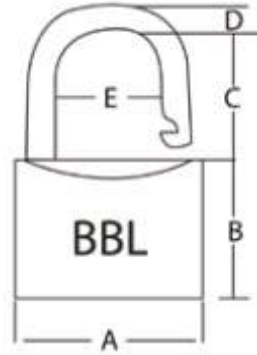

- Anti-corrosion Brass Body
- Double Locking
- Hardened Steel Shackle
- Brass Cylinder

CODE	A	B	C	D	E	BARCODE	KEYBLANK
BBP920-1	20mm	19.1mm	12.0mm	3.00mm	9.70mm	6009647449580	BB20
BBP925-1	25mm	24.4mm	14.1mm	4.00mm	12.70mm	6009647449658	BB25
BBP930-1	30mm	28.3mm	17.0mm	4.80mm	15.80mm	6009647449726	BB30
BBP940-1	40mm	33.0mm	23.8mm	6.40mm	22.60mm	6009647449832	BB40
BBP950-1	50mm	40.3mm	29.4mm	7.90mm	28.00mm	6009647449900	BB50
BBP960-1	60mm	45.5mm	33.7mm	9.50mm	35.60mm	6009647449931	BB50

## BBL Long Shackle Padlocks

CODE	A	B	C	D	E	BARCODE	KEYBLANK
BBP940LS63-1	40mm	33.7mm	63.0mm	6.35mm	21.85mm	6009695281637	BB40
BBP940LS90-1	40mm	33.7mm	90.0mm	6.35mm	21.85mm	6009695281644	BB40
BBP950LS63-1	50mm	40.3mm	63.0mm	8.00mm	28.00mm	6009695281651	BB50
BBP950LS76-1	50mm	40.3mm	76.0mm	8.00mm	28.00mm	6009695281668	BB50

## BBL Multi-Packs



BBP940-2



BBP940-3



BBP940-4

CODE	SIZE	PACK CONTENT	BARCODE	KEYBLANK
BBP920-2	20mm	2x20mm Keyed Alike	6009647449597	BB20
BBP920-3	20mm	3x20mm Keyed Alike	6009647449603	BB20
BBP920-4	20mm	4x20mm Keyed Alike	6009647449610	BB20
BBP930-2	30mm	2x30mm Keyed Alike	6009647449733	BB30
BBP930-3	30mm	3x30mm Keyed Alike	6009685281743	BB30
BBP930-4	30mm	4x30mm Keyed Alike	6009695281699	BB30
BBP930-6	30mm	6x30mm Keyed Alike	6009695282290	BB30
BBP940-2	40mm	2x40mm Keyed Alike	6009647449849	BB40
BBP940-3	40mm	3x40mm Keyed Alike	6009647449856	BB40
BBP940-4	40mm	4x40mm Keyed Alike	6009647449863	BB40
BBP950-2	50mm	2x50mm Keyed Alike	6009647449917	BB50
BBP950-3	50mm	3x50mm Keyed Alike	6009680041505	BB50
BBP950-4	50mm	4x50mm Keyed Alike	6009680041512	BB50

# PADLOCKS

## BBL Discus Padlocks



BBP170-1



BBP170-2

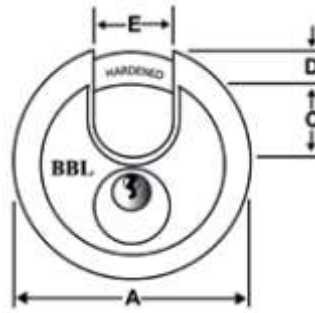

- Concealed, Protected, Hardened Steel Shackle
- Stainless Steel Body
- AntiDrill Plate
- Solid Brass Cylinder

CODE	DESCRIPTION	A	C	D	E	BARCODE
BBP160-1	1x60mm Discus Padlock	60mm	12.0mm	8.0mm	17.0mm	6009647449955
BBP170-1	1x70mm Discus Padlock	70mm	17.5mm	9.5mm	22.0mm	6009647449962
BBP170-2	2x70mm Discus Padlock Keyed Alike	70mm	17.5mm	9.5mm	22.0mm	6009647449979
BBP170-4	4x70mm Discus Padlock Keyed Alike	70mm	17.5mm	9.5mm	22.0mm	6009695287769
BBP170-F1	High Security Key - Duplicated by locksmith only	70mm	17.5mm	9.5mm	22.0mm	6009680041147

## BBL Combination Padlocks



BBP830-3



BBP848



BBPA40



BBP850

CODE	SIZE	DESCRIPTION	BARCODE
BBP820-3	20mm	Resetable Combination	6009647449504
BBP830-3	30mm	Resetable Combination	6009617449511
BBP850	50mm	Resetable Combination	6009647449542
BBP848	48mm	Dial Combination	6009647449528
BBP848-K	48mm	Dial Combination with over ride key	6009647449535
BBPA35	35mm	35mm Combination	6009680040140
BBPA40	40mm	40mm Combination	6009647442147

## BBL Marine Padlocks

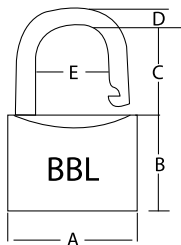

BBP940MP-1

- Stainless Steel Shackle
- Brass Plated Body
- Brass Pins
- Corrosion Resistant

CODE	A	B	C	D	E	KEYBLANK	BARCODE
BBP940MP-1	40mm	33.7mm	22.0mm	6.35mm	21.85mm	BB40	6009695281620
BBP950MP-1	50mm	40.3mm	29.4mm	7.9mm	28.0mm	BB50	6009695281613

# PADLOCKS

## BBL Insurance Padlocks



BBP270-1

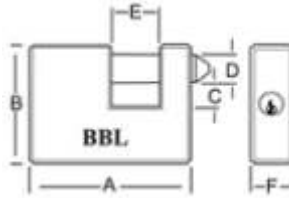

- Brass Body
- Rotating Hardened Steel Shackle
- Anti-Pick Pins
- Stainless Steel Springs

CODE	A	B	C	D	E	F	KEYBLANK	BARCODE
BBP250-1	50mm	38.0mm	11.0mm	7.0mm	16.0mm	15.0mm	BB30	6009680041154
BBP270-1	70mm	55.0mm	15.0mm	12.0mm	22.0mm	20.0mm	BB50	6009680041161
BBP290-1	90mm	65.0mm	18.0mm	12.0mm	36.0mm	20.0mm	BB50	6009680041178
BBP290KA	90mm	65.0mm	18.0mm	12.00mm	36.00mm	20.00mm	BB50	

## BBL Keyed-Alike Padlocks

CODE	A	B	C	D	E	KEYBLANK
BBP920KA	20mm	19.1mm	12.0mm	3.00mm	9.70mm	BB20
BBP925KA	25mm	24.4mm	14.1mm	4.00mm	12.70mm	BB25
BBP930KA	30mm	28.3mm	17.0mm	4.80mm	15.80mm	BB30
BBP940KA	40mm	33.0mm	23.8mm	6.40mm	22.6mm	BB40
BBP950KA	50mm	40.3mm	29.4mm	7.90mm	28.0mm	BB50
BBP960KA	60mm	45.5mm	33.7mm	9.50mm	35.6mm	BB50
BBP170KA	70mm	17.5mm	9.5mm	22.0mm	70mm	BB40
BBP250KA	50mm	38.0mm	11.0mm	7.0mm	16mm	BB50
BBP270KA	70mm	55.0mm	15.0mm	12.0mm	22mm	BB50

## Keytek P M U Padlocks

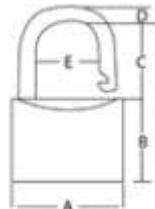

- Brass Body
- Supplied with pins and springs
- Available in 40mm and 50mm
- 40mm Blank VI086
- 50mm Blank VI080

CODE	DESCRIPTION	A	B	C	D	E
BKP940-PMU	Keytek Brass PMU	40mm	33.8mm	22.8mm	6.34mm	22mm
BKP950-PMU	Keytek Brass PMU	50mm	40.8mm	29.25mm	8mm	27.9mm

## Real Padlocks

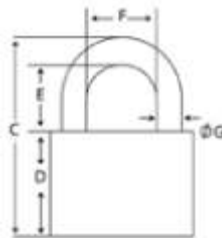

- Zinc alloy die-casting and brass lock body are available.
- Hardened steel, chrome plated shackle
- Brass, molybdenum and stainless steel shackles are available.
- Double steel and stainless steel balls.
- Finish - Shiny chrome plated, brass plated.
- Removable (re-keyable) cylinder
- Anti-drilling & picking
- Master keyed is available upon request.

CODE	A	B	C	D	E	F	G	BARCODE
RL-8032	40mm	21mm	68mm	38mm	23mm	20mm	7mm	6009695288155
RL-8033	50mm	21mm	86mm	42mm	35mm	22mm	9mm	6009695288162
RL-8033KA	50mm	21mm	86mm	42mm	35mm	22mm	9mm	
RL-8033MK	50mm	21mm	86mm	42mm	35mm	22mm	9mm	
RL-8034	60mm	21mm	95mm	45mm	39mm	29mm	11mm	6009695288179
RL-8034KA	60mm	21mm	95mm	45mm	39mm	29mm	11mm	
RL-8034MK	60mm	21mm	95mm	45mm	39mm	29mm	11mm	

# PADLOCKS

## Double Link



## Brass Double Link Padlocks

CODE	SIZE	DESCRIPTION	BARCODE
DL261	20mm	Brass Padlock Boxed	6009695281941
DL261C	20mm	Brass Padlock Carded	6009695281798
DL261KA	20mm	Brass Padlock Keyed Alike	6009695286939
DL262	25mm	Brass Padlock Boxed	6009695281958
DL262C	25mm	Brass Padlock Carded	6009695281804
DL262KA	25mm	Brass Padlock Keyed Alike	6009695282030
DL263	32mm	Brass Padlock Boxed	6009695281965
DL263C	32mm	Brass Padlock Carded	6009695281811
DL263KA	32mm	Brass Padlock Keyed Alike	6009695282047
DL264	38mm	Brass Padlock Boxed	6009695281972
DL264C	38mm	Brass Padlock Carded	6009695281828
DL264KA	38mm	Brass Padlock Keyed Alike	6009695282054
DL265	50mm	Brass Padlock Boxed	6009695281828
DL265C	50mm	Brass Padlock Carded	6009695281835
DL265KA	50mm	Brass Padlock Keyed Alike	6009695282061
DL266	60mm	Brass Padlock Boxed	6009695281996
DL266C	60mm	Brass Padlock Carded	6009695281842
DL266KA	60mm	Brass Padlock Keyed Alike	6009695282078
DL263LS	32mm	Long Shackle Brass Padlock Boxed	6009695282009
DL263LS-C	32mm	Long Shackle Brass Padlock Carded	6009695281859
DL263LSKA	32mm	Long Shackle Brass Padlock Boxed, Keyed Alike	6009695287349
DL264LS	38mm	Long Shackle Brass Padlock Boxed	6009695282016
DL264LS-C	38mm	Long Shackle Brass Padlock Carded	6009695281866
DL264LSKA	38mm	Long Shackle Brass Padlock Boxed, Keyed Alike	6009695287325
DL265LS	50mm	Long Shackle Brass Padlock Boxed	6009695282023
DL263LS-C	50mm	Long Shackle Brass Padlock Carded	6009695281873
DL265LSKA	50mm	Long Shackle Brass Padlock Boxed, Keyed Alike	6009695287332

## Iron Double Link Padlocks

CODE	SIZE	DESCRIPTION	BARCODE
DL361	20mm	Iron Padlock Boxed	6009695282085
DL361C	20mm	Iron Padlock Carded	6009695281880
DL362	25mm	Iron Padlock Boxed	6009695282892
DL362C	25mm	Iron Padlock Carded	6009695281897
DL363	32mm	Iron Padlock Boxed	6009695282108
DL363C	32mm	Iron Padlock Carded	6009695281903
DL363KA	32mm	Iron Padlock Boxed, Keyed Alike	6009695282146
DL364	38mm	Iron Padlock Boxed	6009695282115
DL364C	38mm	Iron Padlock Carded	6009695281910
DL364KA	38mm	Iron Padlock Boxed, Keyed Alike	6009695281910
DL365	50mm	Iron Padlock Boxed	6009695282122
DL365C	50mm	Iron Padlock Carded	6009695281927
DL365KA	50mm	Iron Padlock Boxed, Keyed Alike	6009695282160
DL366	60mm	Iron Padlock Boxed	6009695282139
DL366C	60mm	Iron Padlock Carded	6009695281934
DL366KA	60mm	Iron Padlock Boxed, Keyed Alike	6009695282177
DL363LS	32mm	Long Shackle Iron Padlock Boxed	6009695287356
DL364LS	38mm	Long Shackle Iron Padlock Boxed	6009695287363
DL365LS	50mm	Long Shackle Iron Padlock Boxed	6009695287370

# CISA® PADLOCKS

-  IS A CISA TRADEMARK (MVA)
-  IS A CISA TRADEMARK (MVA)
-  IS A CISA TRADEMARK & PATENTED SYSTEM
-  IS A CISA TRADEMARK & PATENTED SYSTEM
-  IS A HIGH PRECISION REVERSIBLE DIMPLED SYSTEM
-  IS A PATENTED HIGH PRECISION REVERSIBLE DIMPLED KEY SYSTEM



All CISA padlocks are available keyed alike and master keyed.

## CISA® Standard

CODE	DESCRIPTION	A	B	C	D	L	S	KEYBLANK
22010-30	Standard Brass	30mm	29mm	17mm	5mm	17mm	14.5mm	01430
22010-40	Standard Brass	40mm	33mm	24mm	6mm	23mm	16.5mm	01410
22010-50	Standard Brass	50mm	40mm	29.5mm	8mm	27.5mm	17.5mm	01310
22010-60	Standard Brass	60mm	46mm	35mm	10mm	37.5mm	20mm	01310
22010-70	Standard Brass	70mm	53mm	40mm	12mm	44mm	23mm	01210
22610-50	Astral Brass	50mm	40mm	29.5mm	8mm	27.5mm	17.5mm	00620
22080-50	SP Brass	50mm	40mm	29.5mm	8mm	27.5mm	17.5mm	00450

## CISA® Long Shackle

CODE	DESCRIPTION	A	B	C	D	L	S	KEYBLANK
22011-30	Standard Long Shackle Brass	30mm	29mm	17mm	5mm	24mm	14.5mm	01430
22011-31	Standard Long Shackle Brass	30mm	29mm	17mm	5mm	65mm	14.5mm	01430
22011-40	Standard Long Shackle Brass	40mm	33mm	24mm	6mm	40mm	16.5mm	01410
22011-41	Standard Long Shackle Brass	40mm	33mm	24mm	6mm	63.5mm	16.5mm	01410
22011-50	Standard Long Shackle Brass	50mm	40mm	29.5mm	8mm	80mm	17.5mm	01310
22011-52	Standard Long Shackle Brass	50mm	40mm	29.5mm	8mm	127mm	17.5mm	01310
22611-50	Astral Long Shackle Brass	50mm	40mm	29.5mm	8mm	80mm	17.5mm	00620
22611-52	Astral Long Shackle Brass	50mm	40mm	29.5mm	8mm	127mm	17.5mm	00620
22081-50	SP Long Shackle Brass	50mm	40mm	29.5mm	8mm	80mm	17.5mm	00450
22081-52	SP Long Shackle Brass	50mm	40mm	29.5mm	8mm	127mm	17.5mm	00450

## CISA® Key Retaining - Key only removable when shackle in closed position

CODE	DESCRIPTION	A	B	C	D	L	S	KEYBLANK
22012-40	Brass Key Retaining Padlock	40mm	33mm	24mm	6mm	23mm	16.5mm	
22012-50	Brass Key Retaining Padlock	50mm	40mm	29.5mm	8mm	27.5mm	17.5mm	

## CISA® Marine Padlocks



- Brass Chrome Plated Body
- Key Retaining

CODE	DESCRIPTION	A	C	D	L	S
21710-30	Marine Padlock	30mm	14.5mm	4mm	13.8mm	12.8mm
21710-40	Marine Padlock	40mm	19.5mm	4.75mm	22.5mm	13.5mm
21710-50	Marine Padlock	50mm	28.2mm	6.35mm	26mm	14.8mm
21710-60	Marine Padlock	60mm	31.3mm	7.9mm	32.2mm	16.1mm

## CISA Stainless Steel Shackle

CODE	DESCRIPTION	A	B	C	D	L	S	KEYBLANK
22019-30	Brass - Stainless Steel Shackle	30mm	29mm	17mm	5mm	17mm	14.5mm	01430
22019-40	Brass - Stainless Steel Shackle	40mm	33mm	24mm	6mm	23mm	16.5mm	01410
22019-50	Brass - Stainless Steel Shackle	50mm	40mm	29.5mm	8mm	27.5mm	17.5mm	01310
22019-60	Brass - Stainless Steel Shackle	60mm	46mm	35mm	10mm	37.5mm	20mm	01310
22619-50	Astral - Stainless Steel Shackle	50mm	40mm	29.5mm	8mm	80mm	17.5mm	00620
22089-50	SP - Stainless Steel Shackle	50mm	40mm	29.5mm	8mm	80mm	17.5mm	00460

## CISA Insurance Padlocks



21610-70



26509-77

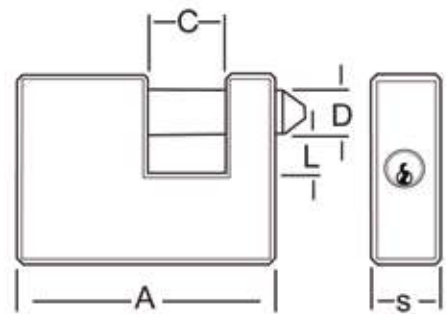

- Solid Brass Body
- Slide Action Shackle
- Hardened Stainless Steel Locking Device

- Available Keyed Alike & Master Keyed
- 26509 Available PMU

CODE	DESCRIPTION	A	C	D	L	S	KEYBLANK
26509-77	Brass Insurance	77mm	27mm	12mm	13.5mm	20mm	01310
26509-94	Brass Insurance	94mm	36mm	12mm	17.5mm	20mm	01310
21610-50	Brass Insurance Logoline	52mm	15mm	8mm	13.5mm	14.7mm	01040
21610-63	Brass Insurance Logoline	63mm	19mm	10mm	13.5mm	18.5mm	01040
21610-70	Brass Insurance Logoline	70mm	22.1mm	12mm	13.5mm	20mm	01040
21610-90	Brass Insurance Logoline	90mm	35mm	12mm	18mm	22.5mm	01040

## CISA P M U Padlocks

P M U Padlocks

- can be specified left or right
- available in long shackle padlocks
- supplied with plug and shackles fixed
- 2 keys supplied per padlock
- supplied without pins and springs



CODE	DESCRIPTION	A	B	C	D	L	S	KEYBLANK
22071-30	CISA 30mm PMU	30mm	29mm	17mm	5mm	17mm	14.5mm	01430
22071-40	CISA 40mm PMU	40mm	33mm	24mm	6mm	23mm	16.5mm	01410
22071-50	CISA 50mm PMU	50mm	40mm	29.5mm	8mm	27.5mm	17.5mm	01310
22071-60	CISA 60mm PMU	60mm	46mm	35mm	10mm	37.5mm	20mm	01310



# YALE PADLOCKS



## Yale Standard

CODE	SIZE	DESCRIPTION	BARCODE
DY110-20-111-1	20mm	Bass Padlock Carded	6001843171159
DY110-30-117-1	30mm	Bass Padlock Carded	6001843171180
DY110-40-123-1	40mm	Bass Padlock Carded	6001843171241



## Yale Multi-Packs

CODE	SIZE	DESCRIPTION	BARCODE
DY110-20-111-2	20mm	Brass Padlock 2 Keyed Alike Carded	6001843171166
DY110-20-111-4	20mm	Brass Padlock 4 Keyed Alike Carded	6001843171173
DY110-30-117-2	30mm	Brass Padlock 2 Keyed Alike Carded	6001843171197
DY110-30-117-3	30mm	Brass Padlock 3 Keyed Alike Carded	6001843171203
DY110-30-117-4	30mm	Brass Padlock 4 Keyed Alike Carded	6001843171210
DY110-40-123-2	40mm	Brass Padlock 2 Keyed Alike Carded	6001843171258
DY110-40-123-4	40mm	Brass Padlock 4 Keyed Alike Carded	6001843171265
DY110-40-123-6	40mm	Brass Padlock 6 Keyed Alike Carded	6001843171272
DY120-50-127-2	50mm	Brass Padlock 2 Keyed Alike Carded	6001843171425
DY120-50-127-4	50mm	Brass Padlock 4 Keyed Alike Carded	6001843171432



## Yale Long Shackle

CODE	SIZE	DESCRIPTION	BARCODE
DY110-30-150-1	30mm	Brass Padlock Long Shackle Carded	6001843171227
DY110-40-163-1	40mm	Brass Padlock Long Shackle Carded	6001843171289
DY110-50-163-1	50mm	Brass Padlock Long Shackle Carded	6001843171449



## Yale Discus

CODE	SIZE	DESCRIPTION	BARCODE
DY130-70-116-1	70mm	Discus Padlock with Black Plastic Cover	6001843171562
DY130-70-116-2	70mm	Discus Padlock with Black Cover Duo	6001843171579



## Yale Closed Shackle

CODE	SIZE	DESCRIPTION	BARCODE
DY110C-30-115-1	30mm	Brass Closed Shackle Padlock	6001843171319
DY110C-40-119-1	40mm	Brass Closed Shackle Padlock	6001843171326

# YALE PADLOCKS



## Combination Padlocks



CODE	SIZE	DESCRIPTION	BARCODE
DY150-30-125-1	30mm	Combination Padlock Brass Resettable	6001843171395
DY150-40-130-1	40mm	Combination Padlock Brass Resettable	6001843171401
DYTP1-32-119-1	30mm	TSA Luggage Combination Inspect Indicator Grey	4893862036777
DYTP2-26-216-1Y	30mm	TSA Luggage Combination Clip on Shackle Yellow	4893862036685
DYTP3-32-350-1	30mm	TSA Luggage Combination Wire Shackle	4893862036784



YTP1-32-119-1



YTP2-26-216-1



YTP3-32-350-1

TSA is the Transport Security Administration of the USA - enables security personnel to examine the contents of luggage without forcing the lock or damaging the bag. The bag can then be re-locked.

Certain locks have an inspection indicator - indicates if security personnel have accessed the luggage.



## Ratchet Shackle

CODE	SIZE	DESCRIPTION	BARCODE
DY110-50-155-1	50mm	Padlock with Removable Ratchet Shackle Brass	6001843171302

# MODLOCKS



## Modlock - Nylon Padlocks

Nylon Padlocks with Stainless Steel Shackle

Available in Green, Black, Orange, Red, Blue, Yellow, Brown - to order

Available Standard, Keyed Alike, Master Keyed and Grand Master Keyed



Standard Sizes 45mm and 50mm Shackle standard 20mm  
Shackle sizes Available: 28mm 30mm 40mm 48mm

# VIRO PADLOCKS

## Viro Standard



V303.7

CODE	SIZE	DESCRIPTION	BARCODE
V298.7	20mm	Brass Padlock Carded	6009674590071
V299.7	25mm	Brass Padlock Carded	6009674590088
V301	30mm	Brass Padlock Boxed	
V301.7	30mm	Brass Padlock Carded	8005344018065
V302	40mm	Brass Padlock Boxed	
V302.7	40mm	Brass Padlock Carded	8005344018089
V303	50mm	Brass Padlock Boxed	
V303.7	50mm	Brass Padlock Carded	8005344018102
V304	60mm	Brass Padlock Boxed	
V304.7	60mm	Brass Padlock Carded	8005344018126
V305	70mm	Brass Padlock Boxed	

## Viro Multi-Packs



V303.7.2

CODE	SIZE	DESCRIPTION	BARCODE
V308.7.3	20mm	Brass Padlock Trio KA Carded	6009674590347
V301.7.2	30mm	Brass Padlock Duo KA Carded	6009674590095
V301.7.3	30mm	Brass Padlock Trio KA Carded	6009674590125
V301.7.4	30mm	Brass Padlock Quad KA Carded	6009674590156
V302.7.2	40mm	Brass Padlock Duo KA Carded	6009674590101
V302.7.3	40mm	Brass Padlock Trio KA Carded	6009674590132
V302.7.4	40mm	Brass Padlock Quad KA Carded	6009674590163
V303.7.2	50mm	Brass Padlock Duo KA Carded	6009674590118
V303.7.3	50mm	Brass Padlock Trio KA Carded	600967590149
V303.7.4	50mm	Brass Padlock Quad KA Carded	6009674590170



V313.7

## Viro Long Shackle

CODE	SIZE	DESCRIPTION	BARCODE
V312.7	40mm	Brass Long Shackle carded	8005344024677
V313.7	50mm	Brass Long Shackle carded	8005344024691



V302-SLAM

## Viro Pop-Shackle

CODE	SIZE	DESCRIPTION	BARCODE
V302-SLAM	40mm	Pop Shackle	
V303PS	50mm	Pop Shackle	

# PADLOCKS



Discus

-

Marine

-

Insurance



V351.70.7



V379.7



VI06.7

CODE	SIZE	DESCRIPTION	BARCODE
V351.70.7	70mm	Discus Padlock Carded	6009674590323
V375.7	40mm	Marine Padlock Carded	6009674590187
V379.7	50mm	Marine Padlock Carded	6009674590200
VI06.7	78mm	Insurance Padlock Carded	6009674590316



The **ULTIMATE** key protection

Protected by International Patent

Protected by International Trademark Law

The unique patented profile incorporates in the cross section of the key blade the Viro company name, which is also a well known registered trademark. No other manufacturer may produce key blanks or locks bearing the Viro trademark in the key section.

Unlike other security key profiles, our International Patent protects the innovation while International Trademark Law protects the key profile, even when the patent lapses after 15 years.

Standard padlocks and high security padlocks are now available with ViroMax protected key section. Key blanks are not available for sale anywhere in the world and key duplication can only be done by Viro.



CYLINDERS AVAILABLE SOON - JUST ADD PV TO THE STANDARD PRODUCT CODE

# TRI-CIRCLE PADLOCKS



TR262 TR263 TRL264



TR362 TR363 TR364



TR265LS TR365LS

## Brass Tri-Circle Padlocks

CODE	SIZE	DESCRIPTION	BARCODE
TR261	20mm	Brass Padlock Boxed	69012921
TR261C	20mm	Brass Padlock Carded	6901750162625
TR262	25mm	Brass Padlock Boxed	69012952
TR262C	25mm	Brass Padlock Carded	6901750162625
TR262KA	25mm	Brass Padlock Keyed Alike	
TR263	32mm	Brass Padlock Boxed	6901750112637
TR263C	32mm	Brass Padlock Carded	6901750162632
TR263KA	32mm	Brass Padlock Keyed Alike	6901750112637
TR264	38mm	Brass Padlock Boxed	6901750112644
TR264C	38mm	Brass Padlock Carded	6901750162649
TR264KA	38mm	Brass Padlock Keyed Alike	6009647441218
TRL265	50mm	Brass Padlock Boxed	6901750112651
TR265C	50mm	Brass Padlock Carded	
TR265KA	50mm	Brass Padlock Keyed Alike	
TR266	60mm	Brass Padlock Boxed	6901750112668
TR266C	60mm	Brass Padlock Carded	6901750412669
TR266KA	60mm	Brass Padlock Keyed Alike	
TR262-LS	25mm	Long Shackle Brass Padlock Boxed	6009695280678
TR263LS	32mm	Long Shackle Brass Padlock Boxed	6901750112736
TR263LS-C	32mm	Long Shackle Brass Padlock Carded	
TR264LS	38mm	Long Shackle Brass Padlock Boxed	6901750112743
TR264LS-C	38mm	Long Shackle Brass Padlock Carded	
TR265LS	50mm	Long Shackle Brass Padlock Boxed	6009647440631
TR265LS-C	50mm	Long Shackle Brass Padlock Carded	6901750612755

## Iron Tri-Circle Padlocks

CODE	SIZE	DESCRIPTION	BARCODE
TR361	20mm	Iron Padlock Boxed	69012914
TR361C	20mm	Iron Padlock Carded	6901750163615
TR362	25mm	Iron Padlock Boxed	69012945
TR362C	25mm	Iron Padlock Carded	6901750163622
TR363	32mm	Iron Padlock Boxed	6901750113634
TR363C	32mm	Iron Padlock Carded	6901750163639
TR363KA	32mm	Iron Padlock Boxed, Keyed Alike	
TR364	38mm	Iron Padlock Boxed	6901750113641
TR364C	38mm	Iron Padlock Carded	6901750163646
TR364KA	38mm	Iron Padlock Boxed, Keyed Alike	
TR365	50mm	Iron Padlock Boxed	6901750113658
TR365C	50mm	Iron Padlock Carded	
TR365KA	50mm	Iron Padlock Boxed, Keyed Alike	6009647441430
TR366	60mm	Iron Padlock Boxed	6901750113665
TR363LS	32mm	Long Shackle Iron Padlock Boxed	6901750113733
TR364LS	38mm	Long Shackle Iron Padlock Boxed	6901750113740
TR365LS	50mm	Long Shackle Iron Padlock Boxed	6901750113757

# OUR NAME IS OUR STRENGTH – INSIST ON GENUINE TRI-CIRCLE® LOCKS

We are an ISO 9001 Company  
and the only Chinese lock  
manufacturer to be awarded  
the Chinese Gold Medal of Excellence

In 2001 we were also awarded  
the "King of Locks" by the  
China Hardware Products Association

**A** Additionally hardened shackle  
**B** Double shackle latches  
**C** Larger casing  
**D** 5 or more pins with Copper wire pin springs.  
The pins are longer  
**E** 3 Unique multiple grooved keys  
**F** Solid Brass cylinder plug, with rim and anti-picking device

**TRI-CIRCLE**  
The name is our strength

# NIGHTLATCHES

**BIRD**



Solid Brass 555 Cylinder

CODE	DESCRIPTION
0508	Standard Nightlatch Box
0508-VISI	Standard Nightlatch Carded

**BIRD**



CODE	DESCRIPTION
0517	Narrow Style Box
0517-VISI	Narrow Style Carded

**BIRD**



Zinc Alloy 555 Cylinder

CODE	DESCRIPTION
0508B	Standard Nightlatch Box
0508B-VISI	Standard Nightlatch Card

**BIRD**



CODE	DESCRIPTION
2000	Single Cylinder Nightlatch Colours Avail: Brass Plated, Brown, Chrome, Silver, White

**BIRD**



CODE	DESCRIPTION
2000	Double Cylinder Nightlatch Colours Avail: Brass Plated, Brown, Chrome, Silver, White

**BIRD**



Narrow Style

CODE	DESCRIPTION
2001	Single Cylinder Nightlatch Colours Avail: Brown, Silver, White

**BIRD**



CODE	DESCRIPTION
100	Deadlock Nightlatch Single Cylinder

**BIRD**



CODE	DESCRIPTION
200	Deadlock Nightlatch Single Cylinder

**BIRD**



CODE	DESCRIPTION
300	Deadlock Nightlatch Double Cylinder

**BIRD**



CODE	DESCRIPTION
0515	Jimmy Proof Night Latch Single Cylinder

**BIRD**



CODE	DESCRIPTION
0515A	Jimmy Proof Night Latch Double Cylinder

**BIRD**



CODE	DESCRIPTION
5088-Bird	Bird Deadlock Nightlatch Colours Avail: Brown, Silver

# NIGHTLATCHES



CODE	DESCRIPTION
BBL1022	Nightlatch Box
BBL1022-1	Nightlatch Carded

### RIM CYLINDERS FOR NIGHTLATCHES



CODE	DESCRIPTION
555-BOX	Bird Rim Cylinder Brass Boxed
555-VISI	Bird Rim Cylinder Brass Visi
555B-BOX	Bird Rim Cylinder Zinc Alloy Boxed
555B-VISI	Bird Rim Cylinder Zinc Alloy Visi
1x1SDD	Union Rim Cyl. Dimple Keyway Brass
1x1SD	Union Rim Cyl. KB502 Keyway Brass
1x1CH	Union Rim Cyl. KB502 Keyway CH
OG500-00	Cisa Rim Cyl. Brass
OG500-12	Cisa Rim Cyl. NP



- Supplied complete with Brass Cylinder -Standard with 1x1SDD cylinder ( new dimple key )  
 - Anti-Credit Card Latch.  
 - Suitable as secondary security device on external doors.  
 - Available without Cylinder



CODE	DESCRIPTION
1022G	Union Nightlatch Standard incl. Cylinder
L-1022G	Union Nightlatch Standard without cylinder



Supplied complete with Brass Cylinder

Suitable as secondary security device on external doors.



CODE	DESCRIPTION
YDY564G	Yale Nightlatch Standard Keyway



Supplied complete with brass 1x1 rim cylinder.

Anti-Credit Card Latch.

Suitable as secondary security device on external doors.



CODE	DESCRIPTION	BARCODE
DY1022G	Standard Keyway	
DY1022SD	New Dimple Keyway	6003190006894



Supplied standard with striker, all fixing screws and instruction sheet

Cylinder OG500 Nightlatch Cylinder supplied with 2 keys

Can be ordered Keyed Alike or Master Keyed

Available in SP and TSP profiles to order



CODE	DESCRIPTION
54315-60-97	Deadlocking Latch with hold-open device
54340-60-97	Deadbolt only



# GATELOCKS

**UNION**  
ASSA ABLOY



CODE	DESCRIPTION	BARCODE
LH5210	Double Throw Deadlock boxed	
LH5210-1	Double Throw Deadlock carded	6009695283259

**UNION**  
ASSA ABLOY

KEYBLANK CODES

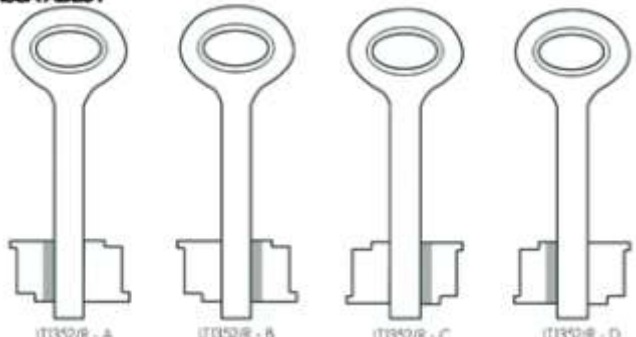

LT1352/R - A    LT1352/R - B    LT1352/R - C    LT1352/R - D

**UNION**  
ASSA ABLOY



KEYBLANK  
LT13033

CODE	DESCRIPTION	BARCODE
LH4145	Sliding Expanda with plate Boxed	
LH4145-1	Sliding Expanda with plate carded	6009695281293

**UNION**  
ASSA ABLOY



KEYBLANK  
LT13033

CODE	DESCRIPTION	BARCODE
LH4115	Sliding Expanda w/o plate boxed	
LH4115-1	Sliding Expanda w/o plate carded	6009695283945

**ELZETT**

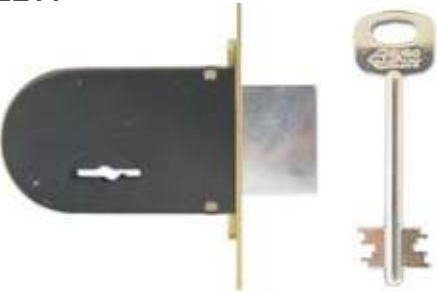

KEYBLANK  
ELZ-IG

CODE	DESCRIPTION	BARCODE
700D	Elzett Deadlock Boxed	5995991100042
700D-1	Elzett Deadlock Carded	6009695282764

**ELZETT**

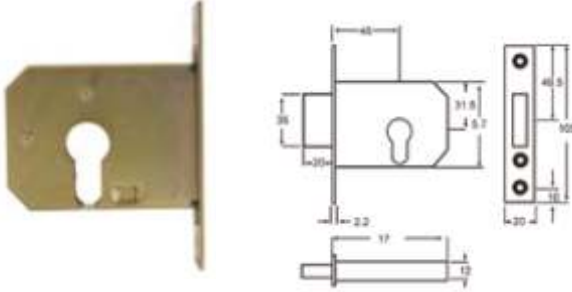

CODE	DESCRIPTION	BARCODE
777D	Elzett Cyl Deadlock Boxed	5997167301239
777D-1	Elzett Cyl Deadlock Carded	6009695282771

**GLADIATOR**



GLADIATOR  
DEAD LOCK  
45mm Backset

Lock Box: GLCBOX

CODE	DESCRIPTION	BARCODE
GLCDL	Cylinder Deadlock Boxed	
GLCDL-1	Cylinder Deadlock Carded	6009695282986

**GLADIATOR**



GLADIATOR  
LATCH LOCK  
45mm Backset

Lock Box: GLCBOX

CODE	DESCRIPTION	BARCODE
GLCLL	Cylinder Latch Lock Boxed	
GLCLL-1	Cylinder Latch Lock Carded	6009695282993

# GATELOCKS

6 Lever Gatelock  
Double Throw Deadbolt  
Steel Forend  
Fits 50 x 25 Steel Tubing

CODE	DESCRIPTION	BARCODE
BBLN302	N302 Deadlock Boxed	6009680041642
BBLN302-1	N302 Deadlock Carded	6009695280012
BBLN302-2	N302 Deadlock 2xKA Carded	6009695280340

6 Lever Deadlock  
Double Throw Deadbolt  
Fits 50 x 25 Steel Tubing

CODE	DESCRIPTION	BARCODE
BBL700	BBL Elzette Gate Lock Boxed	6009647449016
BBL700-1	BBL Elzette Gate Lock Carded	6009680041727
BBL700-2	BBL Elzette Gate Lock 2 x KA	6009680041734
BBL700-3	BBL Elzette Gate Lock 3 x KA	6009680041741

Expanding or sliding  
Security Gates  
Wooden Sliding doors

CODE	DESCRIPTION	BARCODE
BBLN201	Sliding Gate Lock with forend Boxed	6009680041628
BBLN201-1	Sliding Gate Lock with forend Carded	6009680041635
BBLN20IWFP	Sliding Gate Lock without forend Boxed	6009695282252
BBLN20IWFP-1	Sliding Gate Lock without forend Carded	6009695282245

## DEADLOCK

Chrome Finish  
High Security Key  
44.5mm Backset  
Deadbolt Gate Lock

CODE	DESCRIPTION	BARCODE
BBL9409SS-1	Deadlock Star Key Carded	6009695287486

## ULTRA LOCK

Casing can be welded

CODE	DESCRIPTION	BARCODE
ULTRA-S	Ultra Lock Small	6009647442581
ULTRA-L	Ultra Lock Large	6009695288520
ULTRA-E	Ultra Lock 3 Bolt incl cylinder	6009695288186

# GATELOCKS

**BBL** DEADLOCK



BBL9409

CODE	DESCRIPTION	BARCODE
BBL9409	Double-Bolt Deadlock Box	6009647442642
BBL9409-1	Double-Bolt Deadlock Card	6009695287486
J201	Double-Bolt Deadlock Ellis	

**BBL** DEADLOCK

Double Throw Deadlock  
Brass Cylinder Included  
40mm Backset



BBL911240

CODE	DESCRIPTION	BARCODE
BBL911240-1	Deadlock 40mm double Cyl.	6009647446282
BBL911240K-1	Deadlock 40mm Knob Cyl.	6009695280357

**BBL**

Latch & Bolt Mortise Narrow Style  
20mm Backset  
Stainless Steel  
Double Small Oval Cylinder



CODE	DESCRIPTION
CHR375-8	20mm Backset Box

**BBL** CYLINDER HOOK LOCKS

Double Small Oval Cylinder  
15mm Backset  
Strong Laminated Steel Hook  
Fits in 30mm Square Tubing



CODE	DESCRIPTION	BARCODE
BBL910015	15mm backset box	6009695280579
BBL910015-1	15mm backset box	6009647449184

**BBL** CYLINDER SLAM LOCKS

Double Small Oval Cylinder  
15mm Backset  
Strong Laminated Steel Hook  
Sliding Security Gates  
Fits in 30mm Square Tubing



CODE	DESCRIPTION	BARCODE
BBL9100S15-1	15mm backset box	6009695282634
BBL9100S15KA	15mm backset carded	

**BBL**

Double Small Oval Cylinder  
20mm Backset  
Strong Laminated Steel Bolt



CODE	DESCRIPTION	BARCODE
BBL1831	Drop Bolt Lock Narrow Style	6009695287882

**BBL** CYLINDER LATCH LOCKS

Narrow Style Latch Lock  
Double Small Oval Cylinder Included  
Solid Brass Latch



BBL911115

CODE	DESCRIPTION	BARCODE
BBL911115	15mm backset box	6009647442284
BBL911115-1	15mm backset carded	6009647446404

**BBL** CYLINDER LATCH LOCKS

Brass Euro Profile  
Cylinder Included  
Solid Brass Latch



BBL9109-25      BBL9109-40

CODE	DESCRIPTION	BARCODE
BBL9109-25	25mm backset box	6009647440594
BBL9109-25-1	25mm backset carded	
BBL9109-40	40mm backset box	6009647442222
BBL9109-40-1	40mm backset carded	

# LOCKBOXES

**BBL**



For: LH5210 BBLN302  
700D BBL700

CODE	DESCRIPTION
BOX-C	Box Open

**BBL**



For: LH5210 BBLN302  
700D BBL700

CODE	DESCRIPTION
BOX-O	Box Closed

**BBL**



For: 777D GLCDL GLCLL

CODE	DESCRIPTION
GLCBOX	Box for Cylinder Gate Locks

**BBL**

Striker Housing  
Rim Mount N302



CODE	DESCRIPTION
BOX-S	Surface Mount Striker Box

**BBL**



For: LH4145 LH4115 BLN201

CODE	DESCRIPTION
BOX-XPANDA	Box for Xpanda Lock

**BBL**



For: Union 2332

CODE	DESCRIPTION
BOX-U	Union Gate Lock box 2332

**BBL**



For: Zeco Lock

CODE	DESCRIPTION
BOXZ-OPEN	Open Box Zeco
BOXZ-CLOSED	Closed Box Zeco

**BBL**



For: BBL9112-40 deadlock

CODE	DESCRIPTION
BBLBOX-9112	Box for Cyl Deadlock

**BBL**



For: BBL9112-40 deadlock

CODE	DESCRIPTION
BOX-L	Box for Cylinder Deadlock

**CISA**



CODE	DESCRIPTION
421-M	Box for Cisa 42111-30

**CISA**



CODE	DESCRIPTION
423-M	Box for Cisa 42311-50

**CISA**



CODE	DESCRIPTION
523-M	Box for Cisa 52310-60

# CASH BOXES



CODE	SIZE	DESCRIPTION	BARCODE
BBS10	no. 0	125 X 95 X 60	6009680040010
BBS11	no. 1	152 X 118 X 80	6009647445247
BBS12	no. 2	200 X 160 X 90	6009647445254
BBS13	no. 3	250 X 180 X 90	6009647445261
BBS14	no. 4	300 X 240 X 90	6009647445278
BBS15	no. 5	620 X 330 X 400	6009680040027

# KEY CABINETS



CODE	DESCRIPTION	SIZE	BARCODE
KC15-L	Key Cabinet 15 Key Capacity	252 (w) X 300 (h) X 50 (d)	6009647445186
KC25-L	Key Cabinet 25 Key Capacity	252 (w) X 300 (h) X 50 (d)	6009647445193
KC30-L	Key Cabinet 30 Key Capacity	252 (w) X 300 (h) X 50 (d)	6009647445209
KC50-L	Key Cabinet 50 Key Capacity	252 (w) X 540 (h) X 50 (d)	6009647445216
KC100-L	Key Cabinet 100 Key Capacity	400 (w) X 300 (h) X 50 (d)	6009647445223
KC150-L	Key Cabinet 150 Key Capacity	550 (w) X 595 (h) X 50 (d)	6009695288490
KC200-L	Key Cabinet 200 Key Capacity	400 (w) X 1000 (h) X 50 (d)	6009695288506
KC300	Key Cabinet 300 Key Capacity	590.5 (w) X 1001 (h) X 50 (d)	6009695288573
SFK48ENS	Electronic Key Cabinet 48 Key	365 (h) X 300 (w) X 100 (d)	6009695280272

# DEED BOX

# FIRE BOX



DB-LOCAL

CODE	DESCRIPTION
DB-LOCAL	Deed Box Local



SF-FIREBOX

8066

CODE	DESCRIPTION
SF-FIREBOX	Fire Box Local
8066	Fire Bolt Emergency Exit - Red
8066-TUBE	Replacement Glass Tube for Fire Bolt

# SAFES

**BBL**

2 x Manual override keys  
 Uses 4 x AA Batteries  
 Low battery warning



**BBL DIGITAL SAFE SMALL LED**

CODE	SIZE	BARCODE
SFT20EB	200(h) x 310(w) x 200(d)	6009647449214

**BBL**

2 x Manual override keys  
 Uses 4 x AA Batteries  
 Low battery warning



**BBL DIGITAL SAFE MEDIUM LED**

CODE	SIZE	BARCODE
SFT25EB	250(h) x 350(w) x 250(d)	6009647445346

**BBL**

2 x Manual override keys  
 Uses 4 x AA Batteries  
 Low battery warning



**BBL DIGITAL SAFE MEDIUM DROP LED**

CODE	SIZE	BARCODE
SFT25EB-M	250(h) x 350(w) x 250(d)	6009647442000

**BBL**

2 x Manual override keys  
 Uses 4 x AA Batteries  
 Low battery warning



**BBL DIGITAL SAFE LARGE LED**

CODE	SIZE	BARCODE
SFT56ER	520(h) x 350(w) x 360(d)	6009695280319

**BBL**



**BBL DIGITAL SAFE LAPTOP LED**

2 x Manual override keys  
 Uses 4 x AA Batteries - low battery warning

CODE	SIZE	BARCODE
SFT35ERL	200(h) x 430(w) x 350(d)	6009695280326

**BBL**



**BBL DIGITAL SAFE HOTEL VERSION**

Same code used to lock and open door - code clears with each opening - motorized drive - master code available - low battery warning

CODE	SIZE	BARCODE
SFT35EPL	200(h) x 430(w) x 350(d)	6009695280265

**BBL**



**1 - BRICK KEY SAFE**



**BBSF**

CODE	SIZE	BARCODE
BBLB50	145(h) x 310(w) x 115(d)	6009647443137

**BBL**



**2 - BRICK KEY SAFE**



**BBSF**

CODE	SIZE	BARCODE
BBLB53	235(h) x 310(w) x 115(d)	6009695280975

# SAFES



**ELECTRONIC RIFLE SAFE**  
Holds 5 Rifles

Internal Measurements:  
1440(h) x 340(w) x 240(d)

CODE	DESCRIPTION
SFT145GE-5	1450(h) x 350(w) x 300 (d)



**ELECTRONIC OFFICE SAFE**

CODE	SIZE
SFT-30EH	300(h) x 380(w) x3005(d)



**ELECTRONIC FINGERPRINT SAFE**

CODE	SIZE
SFT--35EF	200(h) x 430(w) x350(d) Laptop Safe
SFT-36EF	380(h) x 350(w) x360(d) Office Safe

# SAFE LOCKS

**SARGENT AND GREENLEAF**



7600-003



D220-223



R167-001



7600-005



U32



U19



6731-017

CODE	DESCRIPTION
6731-017	Combination S&G 4 wheel
7600-003	Cover Lockable Dial
7600-005	Cyl. Lock & Keys
D220-223	Comb. Dial with Spindle
R167-001	Comb Dial Ring Spyproof
U19	Spindle key
U32	Long combination change key

# SAFE LOCKS



**UNION**  
ASSA ABLOY

CODE	DESCRIPTION
LG3103/R	N84-1/3 Mazak Key
LG2122RM	N85 1/3 Steel Key



**UNION**  
ASSA ABLOY

CODE	DESCRIPTION
LG6177/R	N95 1/3 Mazak Key



**UNION**  
ASSA ABLOY

CODE	DESCRIPTION
LG1109	Post Box Lock 7 Lever



**UNION**  
ASSA ABLOY

CODE	DESCRIPTION
LG2500	Euro Safe Lock



**BBL**  
7 LEVER SAFE LOCK

BBL Safelock  
7 Lever Locking  
Steel Laminated Deadbolt  
N8 Safeblank  
Also Available Boxed

CODE	DESCRIPTION	BARCODE
BBLN8-1	7 Lever Safe Lock	6009680041604



**BBL**

CODE	DESCRIPTION
TP24-404	3-Wheel Combination Safe



**BBL**  
HEAVY-DUTY SAFE LOCK

Heavy Duty Safelock  
7 Lever Locking  
Steel Laminated Deadbolt  
N8 Safeblank  
Also Available Boxed

CODE	DESCRIPTION	BARCODE
BBLN94-1	Heavy Duty Dual Keyway	6009680041697



Blank - BBLSS - Double Bit Safeblank

CODE	DESCRIPTION
SFT-BBL-LOCK	BBL Safelock -old



Safe Lock for BBL 1-brick and 2-brick safe - New - Pipe Blank BBSF

CODE	DESCRIPTION
BBLSF	BBL Safelock 3-Pin - new



**BBL**

CODE	DESCRIPTION
SFT-EA-LOCKS	Tubular Camlock SFT



# CUPBOARD LOCKS

**EVERGOOD**



CODE	DESCRIPTION
137BP	19x32mm Brass Std.
137CP	19x32mm CP Std.
138BP	19x22mm Brass Std.
138CP	19x22mm CP Std.

**EVERGOOD**



CODE	DESCRIPTION
128CP	Latch 19x22mm CP Std.
128CP-KA	Latch 19x22mm CP KA

**EVERGOOD**



CODE	DESCRIPTION
202BP	Sliding 19x22mm BP Std.
202BP-KA	Sliding 19x22mm BP KA
202CP	Sliding 19x22mm CP Std.
202CP-KA	Sliding 19x22mm CP KA

**UNION ASSA ABLOY**



CODE	DESCRIPTION
420-64/1	1 Lever 64mm BP

**UNION ASSA ABLOY**



CODE	DESCRIPTION
423-51/1	2 Lever 51mm BP
423-64/1	2 Lever 64mm BP
423-76/1	2 Lever 76mm BP

**UNION ASSA ABLOY**



CODE	DESCRIPTION
427-76/1	3 Lever 76mm BP

**UNION ASSA ABLOY**



CODE	DESCRIPTION
435-64	3 Lever Cased Cupb Lock

**UNION ASSA ABLOY**



CODE	DESCRIPTION
452-22PL	Cyl Deadlock 22mm PL
452-25PL	Cyl Deadlock 25mm PL
452-32PL	Cyl Deadlock 32mm PL
452-38PL	Cyl Deadlock 38mm PL

**UNION ASSA ABLOY**



CODE	DESCRIPTION
452-22NP	Cyl Deadlock 22mm NP
452-25NP	Cyl Deadlock 25mm NP
452-32NP	Cyl Deadlock 32mm NP
452-38NP	Cyl Deadlock 38mm NP

**UNION ASSA ABLOY**



CODE	DESCRIPTION
467-22PL	Latch Drawlock 22mm PL
467-22NP	Latch Drawlock 22mm NP

**UNION ASSA ABLOY**



CODE	DESCRIPTION
462-22LPL	Latch 22mm L/H Brass
462-22RPL	Latch 22mm R/H Brass
462-22LNP	Latch 22mm L/H NP
462-22RNP	Latch 22mm L/H NP

**UNION ASSA ABLOY**



CODE	DESCRIPTION
462-38LPL	Latch 38mm L/H Brass
462-38RPL	Latch 38mm R/H Brass
462-38LNP	Latch 38mm L/H NP
462-38RNP	Latch 38mm L/H NP

# CUPBOARD LOCKS



**BBL**  
5 Pin Pick Resistant Barrel

CODE	DESCRIPTION
BBL45222NP	22mm Cylinder NP Box
BBL45222NP-1	22mm Cylinder NP card
BBL45222BP	22mm Cylinder BP Box
BBL45222BP-1	22mm Cylinder BP card



**UNION**  
ASSA ABLOY

CODE	DESCRIPTION
LC62071	WFLII Brass
LC62072	WFLII Chrome



**BIRD**

CODE	DESCRIPTION
O502	Bird Drawer Lock BP



**UNION**  
ASSA ABLOY

CODE	DESCRIPTION
LC6315	WFL12



SAF-20 SAF-Key

CODE	DESCRIPTION
SAF-20	
SAF-20DUO	Saf Lock & Key Carded



**UNION**  
ASSA ABLOY

CODE	DESCRIPTION
LG4102/R	Locker Lock



**UNION**  
ASSA ABLOY

CODE	DESCRIPTION
LN2421	Knob Locking Right Hand
LN2422	Knob Locking Left Hand



**UNION**  
ASSA ABLOY

Cupboard Catch Push Button

CODE	DESCRIPTION
CZ5174CH	Cupb. Pushlock No Key
CZ5174CH	Cupb. Pushlock with Key



**FIRSTLOCK**

CODE	DESCRIPTION
FL16020005	Dummy L-Handle CH



**EVERGOOD**

CODE	DESCRIPTION
119-CP	Glass Lock Single Door



**EVERGOOD**

CODE	DESCRIPTION
248-CP	Glass Lock Double Door



**EVERGOOD**

Sliding Glass Door Lock

CODE	DESCRIPTION
220-CP	Showcase Ratchet

# CUPBOARD LOCKS



**Viro**

CODE	DESCRIPTION
V1421	Filing Cabinet Pushlock Brass
V1421.9	Filing Cabinet Pushlock NP



**UNION**  
ASSA ABLOY

CODE	DESCRIPTION
LC2114	WFL1



**UNION**  
ASSA ABLOY

CODE	DESCRIPTION
LC2205	WFL2

**FIRSTLOCK**



60 Series

CODE	DESCRIPTION
FL13465321	Filing Cabinet Lock

**EVERGOOD**



CODE	DESCRIPTION
109-CP	Draw Lock 19x22mm Round

**FIRST LOCK**



CODE	DESCRIPTION
FL5641573	Tabour Lock



**UNION**  
ASSA ABLOY

CODE	DESCRIPTION
LC2508	WFL24



**UNION**  
ASSA ABLOY

CODE	DESCRIPTION
LC2602	WFL25



**UNION**  
ASSA ABLOY

CODE	DESCRIPTION
LC2719	WFL26

**EVERGOOD**



CODE	DESCRIPTION
288-CP	Camlock Central Drawer Std



**UNION**  
ASSA ABLOY

CODE	DESCRIPTION
LB6182	Z44 Multi-Drawer Lock



**UNION**  
ASSA ABLOY

CODE	DESCRIPTION
LB7130	X44DR

# CAMLOCKS

## EVERGOOD PUSHLOCK



CODE	DESCRIPTION
104BP	21.5 x 24.5mm Brass
104BP-KA	21.5 x 24.5mm Brass KA
104CP	21.5 x 24.5mm Chrome
104CP-KA	21.5 x 24.5mm Chrome KA

## EVERGOOD PUSHLOCK



CODE	DESCRIPTION
105BP	19 x 23mm Brass
105BP-KA	19 x 23mm Brass KA
105CP	19 x 23mm Chrome
105CP-KA	19 x 23mm Chrome KA

## FIRSTLOCK



CODE	DESCRIPTION
FL56125326	Tambour 16.2 x 23mm



CODE	DESCRIPTION
LC3734	WFL29



CODE	SIZE
LA7101	11mm
LA2116	16mm
LA1106	19mm
LA41034	22mm
LA5106	27mm
LA3106	32mm

## EVERGOOD



CODE	SIZE
103-16	16mm
103-25	25mm
103-30	30mm

## REAL



CODE	SIZE
RL8041	16mm
RL8042	23mm
RL8044	34mm



Key Removable in Vertical Position only  
Available in TSP and Astral

CODE	SIZE	DESCR
72250-26-12	26mm	Standard
72275-26-12	26mm	SP



CODE	SIZE	DESCRIPTION
VI052.9	17.5mm	Chrome
VI053.9	20.5mm	Chrome
VI054.9	26mm	Chrome
VI055.9	31mm	Chrome
VI056.9	36mm	Chrome



CODE	SIZE	DESCRIPTION
VI052	17.5mm	Brass
VI053	20.5mm	Brass
VI054	26mm	Brass

## TUBULAR



CODE	SIZE	DESCR
3302-17KD	17mm	standard
3302-17KA	17mm	keyed alike
3302-23KD	23mm	standard
3302-23KA	23mm	keyed alike
3302-28KD	28mm	standard
3302-28KA	28mm	keyed alike

# KEYRINGS and KEYTAGS

## KEYTAG BOX ASSORTED



CODE	DESCRIPTION
Keytag Asst	300 Keytags

## KEYTAGS



Available in Plain colours: Black, Blue, Dark Blue, Green, Orange, Pink, Purple, Red, White, Yellow

## KEYTAG ORGANISER



Keytag Organiser - 10 tags Assorted Colours

CODE	DESCRIPTION
Keytag-organiser	10 yags asst colours

## KEYRINGS



Keyrings - Alfa, Audi, BMW, Chevrolet, Citroen, Daihatsu, Daewoo, Fiat, Ford, Honda, Hyundai, Isuzu, Kia, Mazda, Mercedes, Mitsubishi, Nissan, Opel, Peugeot, Renault, Tata, Toyota, Volvo, VW

## KEYRINGS



CODE	DESCR
BBR-A00249	Oval for Engraving
BBR-A17047	Heart for Engraving
BBR-D01186	Keyring Soccer Ball

## KEYRINGS SNAP HOOK



CODE	DESCRIPTION
BBRA51BL	Snap Hook 51mm
BBRA61BL	Snap Hook 61mm
BBRA71BL	Snap Hook 71mm

## KEYRING - SPIRAL



TP609-70

CODE	DESCRIPTION
BBR5525	Spiral 12/card Asst Colours
TP609-70	Spiral Small 12/card

## SPLIT RINGS



CODE	SIZE
BBR16-13	16mm OD 13mm ID
BBR19-16	19mm OD 16mm ID
BBR25-22	25mm OD 22mm ID
BBR32-28	32mm OD 28mm ID
BBR35-30	35mm OD 30mm ID
BBR45-40	45mm OD 40mm ID

## SPLIT RINGS



8 Assorted sizes:  
17mm 18mm  
21mm 23mm  
25mm 28mm  
30mm 35mm

CODE	DESCRIPTION
TP609-70	300 Asst Split Rings

## KEYRING - WHISTLES



CODE	DESCRIPTION
BBRWH200	Keyring whistle 12/ card

## KEYRINGS



BBR-1980

BBR-D603B

CODE	DESCRIPTION
BBR-1980	Keyring Belt Clip 12/card
BBR-D603B	Keyring Easy Join 12/card

## KEYRING - MULTI-PURPOSE



BBR501-S

BBR501-C

CODE	DESCR
BBR501-C	12/CARD With Chain
BBR501-S	12/CARD No Chain

# KEYRINGS and KEYTAGS

## KEY IDENTIFIERS



Keycap



Identifier Ring



TP328-INORM

CODE	DESCRIPTION
TP328-INORM	Key Identifier Ring Normal Colour
TP328-INEON	Key Identifier Ring Neon Colour
TP328-KP	Key Identifier Keycap

## KEVRON KEYTAGS



ID5-AC150



ID30-AC50

CODE	DESCRIPTION
ID5-AC150	Jar 150 Pcs Asst. Colours
ID5-AC50	Bag 50 Pcs Asst. Colours

## KEVRON KEYTAGS



ID5-AC100

CODE	DESCRIPTION
ID5-AC100	Box 100 Pcs Asst. Colours

## KEVRON KEYTAGS



ID5-ADP

CODE	DESCRIPTION
ID5-ADP	Kevron Auto Dealer Pack Partially assembled 100 pcs

## KEVRON KEYTAGS



CODE	DESCRIPTION
ID56	Kevron Oblong Picture Holder
ID57	Kevron Square Picture Holder

## KEVRON KEYTAGS



CODE	DESCRIPTION
ID18	Kevron ID Holder

## KEVRON KEYTAGS



ID10-AC50

CODE	DESCRIPTION
ID10-AC50	Kevron Hotel Tag 95 x 56mm

## KEVRON KEYTAGS



ID30-AC50

CODE	DESCRIPTION
ID30-AC50	Kevron Giant tag 74 x 38mm

## SPLIT RINGS - WIRE RINGS



WR19

CODE	DESCRIPTION
WR19	Wire 19mm 1000/bag

## KEYTAGS/DOGTAGS

Brass & Nickle Tags suitable for engraving

CODE	DESCRIPTION
TA008	Heart 25mm NP
TA011	Round 25mm NP
TA012	Round 32mm NP
TA013	Heart 20mm Brass
TA014	Round 25mm Brass
TA015	Round 30mm Brass
TA016	Round 32mm Brass



# BBL CYLINDERS

DESCRIPTION	A	B	C	D	E	F	G	H	I	J
Profile Double Cyl 60mm	33mm	17mm	10mm	25mm	10mm	25mm	60mm	n/a	n/a	n/a
Profile Double Cyl 65mm	33mm	17mm	10mm	27.5mm	10mm	27.5mm	65mm	n/a	n/a	n/a
Profile Knob Cyl 65mm	33mm	17mm	10mm	27.5mm	10mm	27.5mm	65mm	30.5mm	86.9mm	15.4mm

**EURO PROFILE 60mm NP**

- Solid Brass Cylinder
- Anti-pick Pins
- Rust-proof Springs
- Anti-drill Pins

BBC560INP

CODE	DESCRIPTION	BARCODE
BBC560INP	NP Boxed	6009695280517
BBC560INP-1	NP Carded	6009680041260
BBC560INP-2	NP Duo KA Carded	6009680041369
BBC560INP-KA	NP Keyed Alike	

**EURO PROFILE 60mm SB**

- Solid Brass Cylinder
- Anti-pick Pins
- Rust-proof Springs
- Anti-drill Pins

BBC560ISB      BBC560ISB-2

CODE	DESCRIPTION	BARCODE
BBC560ISB	Brass Boxed	6009695280531
BBC560ISB-1	Brass Carded	6009680041284
BBC560ISB-2	Brass Duo KA Carded	6009680041376
BBC560ISB-KA	Brass Keyed Alike	

**EURO PROFILE 65mm NP / SB**

- Solid Brass Cylinder
- Anti-pick Pins
- Rust-proof Springs
- Anti-drill Pins

BBC565INP      BBC565INP-1

CODE	DESCRIPTION	BARCODE
BBC565INP	65mm NP Boxed	6009695280548
BBC565INP-1	65mm NP Carded	6009680041437
BBC565ISB	65mm Brass Boxed	6009680041468
BBC565ISB-1	65mm Brass Carded	

**EURO PROFILE 65mm KNOB CYLINDER**

BBC5652NP

- Solid Brass Cylinder
- Anti-pick Pins
- Rust-proof Springs
- Anti-drill Pins

BBC5652NP-1

CODE	DESCRIPTION	BARCODE
BBC5652NP-1	Knob Cyl 65mm NP Carded	6009695280470

**KEYTEK 65mm EURO CYLINDER**

BKB5651 KEYBLANK      BKC5651NP

- Solid Brass Cylinder
- Restricted Keyway
- Drill Resistant
- Pick Resistant
- Side Pins

BKC5651NP-1

CODE	DESCRIPTION	A	B	C	D	E	F	G
BKC5651NP	Double NP 65mm Box	33mm	17mm	10mm	27.5mm	10mm	27.5mm	65mm
BKC5651NP-1	Double NP 65mm Carded	33mm	17mm	10mm	27.5mm	10mm	27.5mm	65mm
BKC5651SB	Double SB 65mm Box	33mm	17mm	10mm	27.5mm	10mm	27.5mm	65mm
BKC5651SB-1	Double SB 65mm Carded	33mm	17mm	10mm	27.5mm	10mm	27.5mm	65mm

# BBL CYLINDERS

**BBL** OVAL CYLINDERS - SMALL AND LARGE

CODE	DESCRIPTION	A	B	C	D	E	F
BBC254I	Small Oval 54mm Cylinder	28mm	13mm	22mm	10mm	22mm	54mm
BBC665I	Large Oval Cyl 65mm NP	31.5mm	17.5mm	27.5mm	10mm	27.5mm	65mm

**BBL** SMALL OVAL 54mm

- Nickel Plated Brass Body
- Anti-pick Pins

BBC254INP

CODE	DESCRIPTION	BARCODE
BBC254INP-1	54mm NP Carded	6009680041215
BBC254INP-2	54mm NP Carded Duo KA	6009680041383
BBC254ISB-1	54mm SB Carded	6009680041222
BBC254ISB-2	54mm SB Carded Duo KA	6009680041239

**BBL** LARGE OVAL 65mm BRASS / CHROME

- Solid Brass Cylinder
- Rust-proof Springs
- Anti-pick Pins
- Anti-drill Pins

CODE	DESCRIPTION	BARCODE
BBC665INP	65mm NP Boxed	6009695281682
BBC665I9NP	65mm NP Boxed	6009695280555
BBC665INP-1	65mm NP Carded	6009680041291
BBC6659INP	KB502 Keyway NP Boxed	6009680041406
BBC6659INP-1	KB502 Keyway NP Carded	6009695282610
BBC6659INP-KA	KB502 Keyway NP Keyed Alike	n/a
BBC665ISB-1	65mm Brass Carded	6009680041307

**BBL** BBL HALF CYLINDER

BBC5453NP

CODE	BARCODE
BBC5453NP	6009695280494

**BBL** ROLLER SHUTTER

Available Keyed Alike

CODE	BARCODE
BBC999-1	6009680041482

**BBL** FORTRESS CYLINDER

Available Keyed Alike

CODE	BARCODE
BBC20861-1	6009647442734



# BBL CYLINDERS

**BBL** SCREW IN CYLINDER

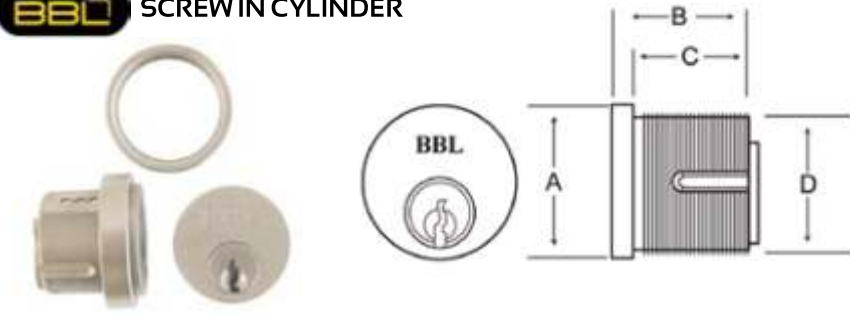

5-Pin Security  
Nickel Plated  
Anti-pick Pins  
Fits Adams Rite  
Lock



CODE	DESCRIPTION	A	B	C	D	BARCODE
BBC325NP-2	1" Screw-in Cylinder	31.7mm	28mm	23.8mm	29mm	6009680041246

BBC325NP-2

**BBL** V CAM CYLINDER



BBC7601SB

CODE	DESCRIPTION	BARCODE
BBC7601SB	V CAM 60mm Brass Box	6009680041857
BBC7601SB-1	V CAM 60mm Brass Card	6009680041765
BBC7601SB-KA	V CAM 60mm Brass KA	n/a

**BBL** HALF V CAM CYLINDER



BBC7403SB

CODE	DESCRIPTION	BARCODE
BBC7403SB	V CAM 40mm Brass Box	6009695280043
BBC7403SB-1	V CAM 40mm Brass card	
BBC7403SB-KA	V CAM 40mm Brass KA	6009680041833

**BIRD NIGHTLATCH RIM CYLINDER**



CODE	DESCRIPTION	BARCODE
555-BOX	Bird Rim Cylinder Brass Box	6009647440372
555-VISI	Bird Rim Cylinder Brass Visi	6009695280654
555B-BOX	Bird Rim Cylinder Zinc Alloy Box	6009695281774
555B-VISI	Bird Rim Cylinder Zinc Alloy Visi	6009695281781

**BBL** GEAR CAM CYLINDER



Available  
Keyed Alike

BBC7606SB

CODE	DESCRIPTION
BBC7606SB	Gear Cam 60mm Box
BBC7606SB-1	Gear Cam 60mm Card

**BBL**

Steel Housing

5-Pin Tumbler Brass Cylinder



BBF999H



BBC999-1



BBF999

Keyed Alike Cylinders Available

Supplied with 2 Keys

CODE	DESCRIPTION	BARCODE
BBF999-1	Bullet Lock with housing	6009647446381
BBC999-1	Roller Shutter Cylinder carded	6009680041482
BBF999H	Bullet Lock Housing Only	6009695280036



**LM** IS A CISA TRADEMARK (LM)

**MLA** IS A CISA TRADEMARK (MLA)

**SP®** IS A CISA TRADEMARK & PATENTED SYSTEM

**TSP®** IS A CISA TRADEMARK & PATENTED SYSTEM

**ASTRAL** IS A HIGH PRECISION REVERSIBLE DIMPLED SYSTEM

**AP3 SYSTEM** IS A PATENTED HIGH PRECISION REVERSIBLE DIMPLED KEY SYSTEM

**INVEST IN YOUR FUTURE  
SELL A CISA PERSONALISED KEYWAY**

CISA has introduced a range of personalised keyways in order to give the discerning locksmith an opportunity to invest in his business. The system is identified by the symbol G on the key head, followed by a code eg. G96. The personalised keyway is normally registered to a locksmith for an area of about 10km radius.

The Advantages for the Locksmith are:  
**Return business** - customers must return for any key duplication to the registered user which brings long term future business that could otherwise go to the local keybar.  
**Add-on Business** - when a KA or MK system is sold it follows that all additions must be referred to the participating locksmith.  
**Up selling** - the personalised keyways introduce the user to the concept of key security presenting opportunities to sell high security personalised systems such as "SP" and "TSP" thus increasing value of sales and increased financial benefits for the locksmith



In response to the growing need to resist the latest developments in illegal lock opening CISA now offer Cylinders **BKP** ( BUMP KEY RESISTENT ) SP TSP ASTRAL AP3 euro profile cylinders are all provided as standard with bump key resistant pins. C2000 and Asix euro profile cylinders can be supplied **BKP** upon request.



01210-1 01210-2 20mm	01310-1 01310-2 50mm	01410-1 01410-2 40mm	01420-1 01420-2 50mm	01430-1 01430-2 30mm	01070-10-00 C2000	A-SIX 00660-01	MLA
----------------------------	----------------------------	----------------------------	----------------------------	----------------------------	----------------------	-------------------	-----



**ASTRAL** 00620-01

**SP** 00450

**AP3**

**TSP**

**CISA manufacture Key Profiles for a variety of security levels and market needs.**

**SP TSP AP3**  
These are Cisa patented systems and the cylinders are supplied with security cards and keys are only cut upon presentation of this card.

**ASTRAL**  
Cylinders are supplied with a Code Card for re-ordering keys by code.

**CISA**  
**LOGOLINE**



Supplied with  
3 Keys

5 Pins

CODE	DESCRIPTION
08010-07-12	Euro Profile Double Cylinder NP 60mm
08010-10-12	Euro Profile Double Cylinder NP 65mm

**CISA**  
**C2000**



Supplied with  
2 Keys

Available in various  
sizes up to 120mm

Available KA, MK  
& GMK to order

CODE	DESCRIPTION
OG302-07-00	Euro Profile Knob Cylinder BP 59mm
OG302-07-12	Euro Profile Knob Cylinder NP 59mm
OG302-10-00	Euro Profile Knob Cylinder BP 65mm
OG302-10-12	Euro Profile Knob Cylinder NP 65mm

**CISA** **EURO PROFILE CYLINDER**

**C2000**



Supplied with 2 Keys

Available Keyed Alike, Master Keyed & Grand Master Keyed to order

CODE	DESCRIPTION
OG300-07-00	Euro Profile Double Cylinder BP 59mm
OG300-07-12	Euro Profile Double Cylinder NP 59mm
OG300-10-00	Euro Profile Double Cylinder BP 65mm
OG300-10-12	Euro Profile Double Cylinder NP 65mm
OG300-13-00	Euro Profile Double Cylinder BP 69mm
OG300-13-00	Euro Profile Double Cylinder NP 69mm
OG300-15-00	Euro Profile Double Cylinder BP 73mm
OG300-15-00	Euro Profile Double Cylinder NP 73mm

**CISA**  
**EURO PROFILE HALF CYLINDER**



Supplied with 2 Keys

Single Cylinder  
Adjustable Cam

CODE	DESCRIPTION
OG304-02-00	Euro Profile 1/2 Cylinder 42.5mm BP
OG304-02-12	Euro Profile 1/2 Cylinder 42.5mm NP

**CISA**  
**EURO PROFILE HALF KNOB CYLINDER**



Supplied with 2 Keys

Knob Cylinder  
Adjustable Cam

CODE	DESCRIPTION
08559-09-00	Euro Profile 1/2 Knob Cylinder 42.5mm BP
08559-09-12	Euro Profile 1/2 Knob Cylinder 42.5mm NP

**CISA**

08210-02-12



08230-02-12

**SMALL OVAL CYLINDER**

Supplied with 2 Keys

Half Cylinder Available 08220-02

CODE	DESCRIPTION
08210-02-12	Small Oval Double Cylinder NP 54mm
08210-02-12-KA	Small Oval Double Cylinder NP 54mm Keyed Alike
08210-18-12	Small Oval Double Cylinder NP 80mm
08230-02-12	Small Oval Knob Cylinder NP 54mm

**CISA**

**TOILET CYLINDER with T-Knob**



For use on toilet doors - no keys

CODE	DESCRIPTION
08525-04-00	61.6mm Knob Cyl BP
08525-04-12	61.6mm Knob Cyl NP
08525-34-00	65mm Knob Cyl BP
08525-34-12	65mm Knob Cyl NP
08525-14-00	69mm Knob Cyl BP
08525-14-12	69mm Knob Cyl NP

**CISA**

**THREADED CYLINDER**



Available in SP, TSP, AP3 & Astral to order

Keyed Alike in Pairs

01310-10-00 Keyblank

CODE	DESCRIPTION
02900	Cisa Threaded Cyl. Single NP
02190	Cisa Threaded Cyl. Pair NP

**CISA**

**LARGE OVAL DOUBLE CYLINDER**



Available Keyed Alike and Master Keyed

Available to order SP, AP3 Astral, A-Six TSP

09010-10-12

CODE	DESCRIPTION
09010-10-00	65mm Double Cyl. BP Std.
09010-10-12	65mm Double Cyl. NP Std.
09010-15-23	73mm Double Cyl. NP Std.
09010-80-23	85mm Double Cyl. NP Std.

**CISA**

**LARGE OVAL KNOB CYLINDER**



Available Keyed Alike and Master Keyed

Available to order SP, AP3 Astral, A-Six TSP

09023-10-12

CODE	DESCRIPTION
09023-10-00	65mm Knob Cyl. BP Std.
09023-10-12	65mm Knob Cyl. NP Std.
09023-15-23	72.6mm Knob Cyl. Std.
09023-80-23	85mm Knob Cyl. Std.

**CISA**

**LARGE OVAL HALF CYLINDER**



Available Keyed Alike and Master Keyed

Available to order SP, AP3 Astral, A-Six TSP

CODE	DESCRIPTION
09026-02-00	1/2 Cyl Double 42.5mm BP
09026-02-12	1/2 Cyl Double 42.5mm NP

**CISA**

**LARGE OVAL HALF KNOB CYLINDER**



Single Cyl. with T- Knob

09090-02-12

CODE	DESCRIPTION
09090-02-00	1/2 Cyl Knob 42.5mm BP
09090-02-12	1/2 Cyl Knob 42.5mm NP

**CISA**

**NIGHTLATCH CYLINDER C2000**



Available Keyed Alike and Master Keyed

Supplied with 2 Keys

Available to order SP, AP3 Astral, A-Six TSP

CODE	DESCRIPTION
OA500-00-00	Nightlatch Cyl Brass
OA500-00-12	Nightlatch Cyl NP

**CISA** Asix



Keys duplicated by Locksmith

Available Keyed Alike and Master Keyed on request

CODE	DESCRIPTION
OE300-07-00	65mm Euro Double Cyl Asix BP
OE300-07-12	65mm Euro Double Cyl Asix NP
OE302-10-00	65mm Euro Knob Cyl Asix BP
OE302-10-12	65mm Euro Knob Cyl Asix NP

## CISA SP

SP Security Profile cylinders are supplied with a security card.  
Keys duplicated only on presentation of this card.  
Duplication only by Cisa or authorised centres.

CODE	DESCRIPTION
08815-07-00	60mm Euro Double Cyl. SP BP
08815-07-12	60mm Euro Double Cyl. SP NP
08815-10-00	65mm Euro Double Cyl. SP BP
08815-10-12	65mm Euro Double Cyl. SP NP
08815-13-66	69mm Euro Double Cyl. SP BP
08815-13-12	69mm Euro Double Cyl. SP NP



BKP

## CISA AP3

AP3 Cylinders are supplied with security cards. Keys only duplicated on presentation of this card  
Available as Knob Cylinder OH312-10  
Duplication only by Cisa or authorised centres.

CODE	DESCRIPTION
OH310-07-12	60mm Euro Cyl AP3 NP
OH310-10-12	65mm Euro Cyl AP3 NP



BKP

## CISA ASTRAL

Cylinders are supplied with a code card for re-ordering keys by code

Available as Knob Cylinder OA312-10

Available Keyed Alike and Master Keyed on request

CODE	DESCRIPTION
OA310-10-00	65mm Euro Double Astral BP
OA310-10-12	65mm Euro Double Astral NP



BKP

## CISA TSP

Top Security Profile  
These cylinders are supplied with a security card.  
Keys duplicated only on presentation of this card. Duplication only by Cisa or authorised centres.

CODE	DESCRIPTION
08810-07-66	60mm Euro Double Cyl. TSP BP
08810-10-12	65mm Euro Double Cyl. TSP NP
08851-04-66	60mm Knob Cyl. TSP BP
08851-04-12	60mm Knob Cyl. TSP NP



BKP

## CISA ELECTRIC LOCK CYLINDERS

**02110** Cylinder Set available for:  
11721 11921 11731 11931  
Rim Electric Locks

**OG150** Cylinder Set available for:  
1A721 1A731  
Eletrika Locks

CODE	DESCRIPTION
02110-00-00	Cyl for Rim Elec Locks Brass Std
OG150-00-00	Cyl for Elektrika Locks Brass Std



## CISA ASTRAL EURO PROFILE CYLINDERS SNAP RESISTANT

Cylinders are: Snap Resistant  
Drill Resistant  
Picking Resistant  
Bump Key Resistant "BKP"

CODE	DESCRIPTION
OA350-10-00	Astral Double Cylinder 65mm BP Snap Resistant
OA350-10-12	Astral Double Cylinder 65mm NP Snap Resistant
OA352-10-66	Astral Knob Cylinder 65mm BP Snap Resistant
OA352-10-12	Astral Knob Cylinder 65mm NP Snap Resistant



BKP

# CYLINDERS

**UNION**  
ASSA ABLOY



CODE	DESCRIPTION
2X18CH	66mm Double Cyl Euro Nickle Plated
2X18PL	66mm Double Cyl Euro Brass
2X18SC	66mm Double Cyl Euro Satin Chrome

**UNION**  
ASSA ABLOY



CODE	DESCRIPTION
2X20CH	32mm Double Cyl Euro Nickle Plated
2X20PL	32mm Double Cyl Euro Brass
2X20SC	32mm Double Cyl Euro Satin Chrome

**UNION**  
ASSA ABLOY



CODE	DESCRIPTION
2X19CH	66mm Knob Cyl Euro Nickle Plated
2X19PL	66mm Knob Cyl Euro Brass
2X19SC	66mm Knob Cyl Euro Satin Chrome

**UNION**  
ASSA ABLOY



CODE	DESCRIPTION
2X13CH	66mm Knob Cyl Large Oval Nickle Plated
2X13PL	66mm Knob Cyl Large Oval Brass
2X13SC	66mm Knob Cyl Large Oval Satin Chrome

**UNION**  
ASSA ABLOY



CODE	DESCRIPTION
2X6CH	66mm Double Cyl Large Oval Nickle Plated
2X6PL	66mm Double Cyl Large Oval Brass
2X6SC	66mm Double Cyl Large Oval Satin Chrome

**UNION**  
ASSA ABLOY



CODE	DESCRIPTION
2X8PL	32.5mm Large Oval Half Cylinder Brass
2X8SC	32.5mm Large Oval Half Cylinder CH

**UNION**  
ASSA ABLOY



CODE	DESCRIPTION
2X11CH	Union Threaded Cylinder CH
2X11PL	Union Threaded Cylinder Brass

**UNION**  
ASSA ABLOY



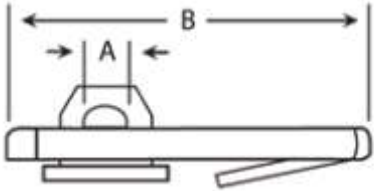
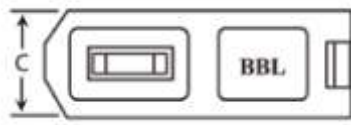

CODE	DESCRIPTION
1X1SD	Rims Cyl for Nightlatch KB502 profile Brass
1X1CH	Rims Cyl for Nightlatch KB502 profile Chrome
1X1SD	Rims Cyl for Nightlatch Dimple Keyway Brass

# HASP & STAPLES

- Concealed Fixing
- Complete with Fixings

CODE	DESCRIPTION	A	B	C	BARCODE
BBH620-060	Hasp and Staple BBL	7mm	60mm	20mm	6009680041185
BBH620-080	Hasp and Staple BBL	9mm	80mm	27mm	6009680041192
BBH620-100	Hasp and Staple BBL	10mm	100mm	30mm	6009680041208
BBHIII-155	Hasp and Staple BBL	12.2mm	155mm	45mm	6009680041352

BBH5100

Supplied complete with fixing screws

CODE	DESCRIPTION	BARCODE
BBH5063	Hasplock BBL 63mm	6009647442154
BBH5075	Hasplock BBL 75mm	6009647442161
BBH5100	Hasplock BBL 100mm	6009647442178
BBH5115	Hasplock BBL115mm	6009647442383



BBLHASP-BR

- Concealed Fixing
- Solid Brass

CODE	DESCRIPTION
BBLHASP-BR	Heavy Duty Brass
BBLHASP-CP	Heavy Duty CH



BBL535

- Supplied complete with fixing screws
- Hardened steel
- Concealed Fixing

CODE	DESCRIPTION
BBL535	Hasp BBL





CISA

- Supplied complete with fixing screws
- Hardened steel
- Concealed Fixing

CODE	DESCRIPTION
06300-18	Hasp Cisa

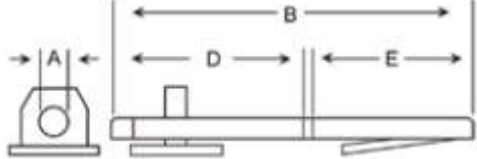

- Supplied complete with fixing screws
- Concealed Fixing
- For use around corners and angles
- Tough steel construction

CODE	DESCRIPTION	A	B	C	D	E	BARCODE
BBHIII-155	Hasp and Staple BBL	12.2mm	155mm	45mm	85mm	70mm	6009680041352



V0699.9



V0699.9

CODE	DESCRIPTION
V0699.9	Heavy Duty Hasp & Staple Brass
V0699.9	Heavy Duty Hasp & Staple Chrome



### SECURITY BOLT



1 Star Key per Pack

CODE	DESCRIPTION	BARCODE
BBL090316-1	60mm Security Bolt	6009647446237
BBL090316-2	60mm Security Bolt Duo	6009695282306



### DOORVIEWER



180° wide angle lens



CODE	DESCRIPTION	BARCODE
BBF03BP	Doorviewer BBL Brass	6009647442246
BBF03CH	Doorviewer BBL Chrome	6009647444042



### KEYHOLE BLOCKER

Fits all standard Lever Mortice Locks

Prevents access by foreign keys

Duo Pack Keyed Alike



CODE	DESCRIPTION	BARCODE
BBF900-1	Keyhole Blocker BBL	6009647444608
BBF900-2	Keyhole Blocker duo pack	6009695280302



### INDICATOR BOLT

Indicates whether toilet is vacant or occupied.

Fits any Standard Door



CODE	DESCRIPTION	BARCODE
BBF80941CH-1	Indicator Bolt Chrome	6009695281125



### DOORCHAIN

Complete with fixing screws



CODE	DESCRIPTION	BARCODE
BBF620B	Doorchain Brass Carded	6009695280135
BBF620C	Doorchain Chrome Carded	6009695280128



### DOORCHAIN

Complete with fixing screws



CODE	DESCRIPTION
BBL640B	Doorchain Bolt Locking Brass
BBL640C	Doorchain Bolt Locking CH



# DOOR FITTINGS



**UNION**  
ASSA ABLOY

Complete with fixing screws

CODE	DESCRIPTION
CZ8731BP	Doorstop Halfmoon BP
CZ8731CH	Doorstop Halfmoon CH
CZ8731SC	Doorstop Halfmoon SC



**BBL**

CODE	DESCRIPTION	BARCODE
A08-PB	Door Guard Fighter Brass	6009647443649
A08-SS	Door Guard Fighter SS	6009647443656



**BBL**

Lockout Hasps allow multiple padlocks to be used - each person having their individually keyed padlock - fits most standard sized shackles

CODE	DESCRIPTION
BBF-25	Lockout Hasp BBL
BL-25	Lockout Hasp Master

# CHUBB LOCKS



V8001-PL



V8013-2PL



V8002-PL



V8001K-2



V-WS12-2-WE



V8002-2-WE

- Window Bolts - Bolt morticed for increased security  
Prevents opening by releasing catch.
- Door Bolts - Simple to fit and operate Bolt morticed for increased security.  
- Deters intruders access through door
- Hinge Bolts - Protects hinged side of door from force attack
- Door Bolt Key - Suitable for use with Chubb Window Bolts and Door Bolts

CODE	DESCRIPTION	BARCODE
V8001-PL	Window Security Bolt Brass	5011783000083
V8001-WE	Window Security Bolt White	
V8013-2PL	Sash Window Bolts 2-pack Brass	
V8001K-2	Keys for Security Bolt Duo	5011783000120
V8002-2-WE	Door Security Bolt White Duo	5011783002162
V8002-PL	Door Security Bolt Brass Single	5011783000106
V-WS12-2-WE	Hinge Bolts White	5011783000328

# PATIO LOCKS

## Evergood

Patio Pushlocks available Keyed Alike



280-BP

280-SIL

CODE	DESCRIPTION	BARCODE
280-BLK	Patio Pushlock Black Plated	6009695287417
280-BLK-1	Patio Pushlock Black Plated Carded	
280-BP	Patio Pushlock Brass Plated	6009695280623
280-BP-1	Patio Pushlock Brass Plated Carded	6009695282566
280-BRN	Patio Pushlock Brown	
280-BRN-1	Patio Pushlock Brown Carded	6009695282580
280-CP	Patio Pushlock Chrome Plated	6009695280630
280-CP-1	Patio Pushlock Chrome Plated Carded	6009695282542
280-SIL	Patio Pushlock Silver	6009680280838
280-SIL-1	Patio Pushlock Silver Carded	6009695282603
280-WH	Patio Pushlock White	6009695280647
280-WH-1	Patio Pushlock White Carded	6009695282573



BBL40IGR-1



BBL40IGR-2



CODE	DESCRIPTION	BARCODE
BBL40IBRN-1	Patio Bolt Brown	6009680041345
BBL40IGR-1	Patio Bolt Grey	6009680041321
BBL40IGR-2	Patio Bolt Grey 2 Keyed Alike	6009680041314
BBL40IWH-1	Patio Bolt White	6009680041338
BBL4I08	Patio Bolt Silver	6009647443779



BBL402WH-1



BBL4218



CODE	DESCRIPTION	BARCODE
BBL402WH-1	Multipurpose Springloaded white	6009680041673
BBL402WH-2	Multipurpose Springloaded white KA duo	6009680041680
BBL4218	Patio Panda Pushlock PA218	6009647442192



BBFWIS-1



PDL-031



BBC20861

CODE	DESCRIPTION	BARCODE
BBFWIS-1	BBL Patio Door Handle	6009695282214
PDL-013	Latch	
PDL-031-1	Latch	6009695283228
BBC20861-1	BBL Fortress Cylinder Std. Carded	6009647442734
BBC20861KA	BBL Fortress Cylinder Keyed Alike	6009695280562

## SUGGESTED APPLICATIONS FOR PANIC DEVICES

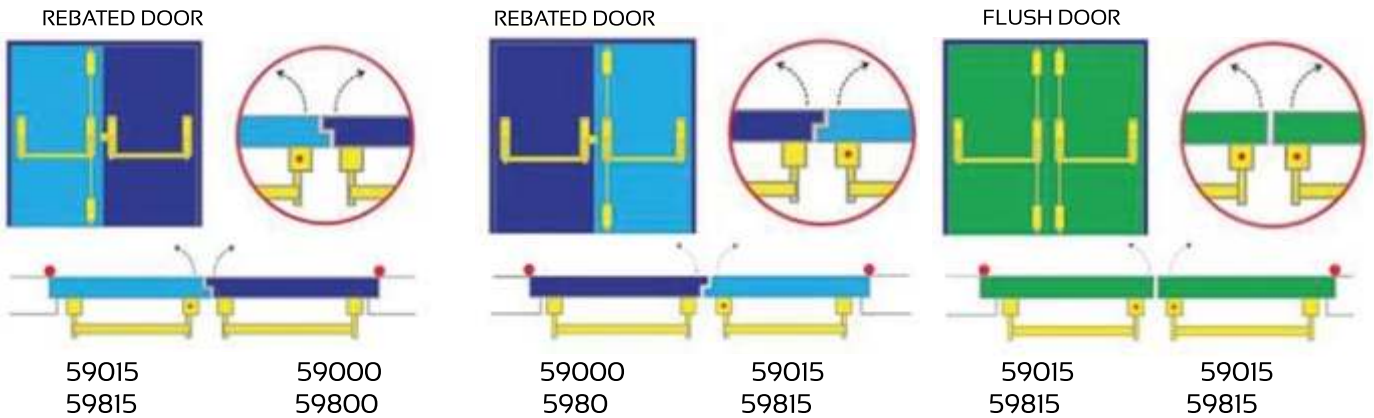

- Main door = A**  
use only lateral locking points (one or more)
- Independent door = C**  
always use only top and bottom locking points
- Secondary door = B**  
always use only top and bottom locking points

Panic Exit Devices  
Operation: - from the inside by pushing the bar  
- from the outside with key and/or handle

Supplied with:  
- Special Strikers  
- Fixing Screws  
- Installation & Maintenance Instructions



Self-locking side latch bolt - complete with striker  
Easy to install - on wooden, steel or aluminium doors

All CISA panic devices are certified

CODE	DESCRIPTION
59000-10-00	Panic Exit Device 1200mm Black Case Red Bar
59000-10-97	Panic Exit Device 1200mm Grey Case Grey Bar
59000-11-00	Panic Exit Device 900mm Black Case Red Bar
59000-11-97	Panic Exit Device 900mm Grey Case Grey Bar



Self-locking upper/lower latch bolts - complete with striker

Optional self-locking upper/lower latch bolts

Easy to install - on wooden, steel or aluminium doors

All CISA panic devices are certified

CODE	DESCRIPTION
59015-10-00	Panic Exit Device 1200mm Black Case Red Bar
59015-10-97	Panic Exit Device 1200mm Grey Case Grey Bar
59015-11-00	Panic Exit Device 900mm Black Case Red Bar
59015-11-97	Panic Exit Device 900mm Grey Case Grey Bar





**CISA® RIM TOUCH-BAR PANIC EXIT DEVICE**

Dead-locking upper/lower latch bolts, complete with striker

Easy to install - on wooden, steel or aluminium doors

All CISA panic devices are certified



CODE	DESCRIPTION
59815-10-00	Rim Touch-Bar Panic 1200mm Black Case Red Bar
59815-10-97	Rim Touch-Bar Panic 1200mm Grey Case Grey Bar
59815-11-00	Rim Touch-Bar Panic 840mm Black Case Red Bar
59815-11-97	Rim Touch-Bar Panic 840mm Grey Case Grey Bar



**CISA® RIM TOUCH-BAR PANIC EXIT DEVICE**

Dead-locking side latch bolt - complete with striker

Easy to install - on wooden, steel or aluminium doors

All CISA panic devices are certified

CODE	DESCRIPTION
59800-10-00	Rim Touch-Bar Panic 1200mm Black Case Red Bar
59800-10-97	Rim Touch-Bar Panic 1200mm Grey Case Grey Bar
59800-11-00	Rim Touch-Bar Panic 840mm Black Case Red Bar
59800-11-97	Rim Touch-Bar Panic 840mm Grey Case Grey Bar



Supplied complete with striker

Easy to install with instructions



CODE	DESCRIPTION
59050-10-97	Push Pad - Lateral Latch-bolt
59060-10-97	Push Pad with Top & Bottom latches & Lateral Latch
59065-10-97	Push Pad with only Top & Bottom Latches



Painted aluminium alloy plate with cylinder for use with Cisa panic devices.

**07077-28**  
For Models:  
59000 59060  
59800 59060  
59015 59815



CODE	DESCRIPTION
07077-28-00	Outside operation device for touch bar Black
07077-28-97	Outside operation device for touch bar Grey



Painted aluminium alloy plate with cylinder for use with Cisa panic devices.

**07077-29**  
For Models:  
59000  
59800  
59050



CODE	DESCRIPTION
07077-29-00	Outside operation device for touch bar Black
07077-29-97	Outside operation device for touch bar Grey



Electric Strikes for Panic Devices

Continuous Pulse  
Reversible  
Fail Secure



CODE	DESCRIPTION
07083-16-00	Electric Strike Black Cover 12V dc 70 ohm
07083-16-97	Electric Strike Grey Cover 12V dc 70 ohm

# PANIC DEVICES



ASSA ABLOY

## 880 series exit hardware

UNION Architectural Hardware introduces an innovative and contemporary range of exit hardware, exclusively designed to suit higher specification new build and replacement markets.

The UNION 880 Series combines quality engineering and high performance with contemporary aesthetics. The range boasts maximum versatility, comprising of both 'touch bar' and 'push bar' variants for single and double doors.

The new range offers a lighter, smoother and quieter alternative to the traditional bolting action. For single doors there is a choice of either a single point latch variant, or 2/3 point locking using upper and lower Pullman latches. For double doors, a choice of 3 and 5 point locking is available.

Guaranteed for 10 years, the UNION 880 Series is CE marked to BS EN 1125\* and fire tested to BS EN 1634 on both timber and metal doors.



ASSA ABLOY

### 88IT TOUCH BAR RANGE

For doors in buildings accessed by the public - where panic can be foreseen.  
Suitable for timber doors  
Non-handed for maximum flexibility  
Complete with appropriate signage and fixing instructions



CODE	DESCRIPTION
88IT	For use on Single Doors 900mm wide
88IT-W	For use on Single Doors 1200mm wide
882T	For use on single Doors 900mm wide with upper & lower Pullman Latches
882T-W	For use on single Doors 1200mm wide with upper & lower Pullman Latches
883T	For use on double rebated doors 900mm wide with upper & lower Pullman Latches
883T-W	For use on double rebated doors 1200mm wide with upper & lower Pullman Latches



ASSA ABLOY

### 881 PUSH BAR RANGE

For doors in buildings accessed by the public - where panic can be foreseen.  
Suitable for timber doors  
Non-handed for maximum flexibility  
Complete with appropriate signage and fixing instructions



CODE	DESCRIPTION
881	For use on Single Doors 900mm wide
881-W	For use on Single Doors 1200mm wide
882	For use on single Doors 900mm wide with upper & lower Pullman Latches
882-W	For use on single Doors 1200mm wide with upper & lower Pullman Latches
883	For use on double rebated doors 900mm wide with upper & lower Pullman Latches
883-W	For use on double rebated doors 1200mm wide with upper & lower Pullman Latches

# DOOR CLOSERS

## DORMA TS77



- For doors of widths: 1.00m weight: 60kg
- For internal and external doors
- Adjustable closing speed for wooden and metal doors
- Easy to install with fixing instructions



TS77-VISI

CODE	DESCRIPTION
TS77-box	Doorcloser Light Duty Box
TS77-VISI	Doorcloser Light Duty Visi

## DORMA TS71

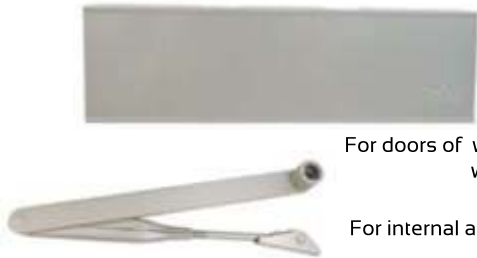

- For doors of widths: 1100mm weight: 80kg
- For internal and external doors

CODE	DESCRIPTION
TS71	Dorma Doorcloser

## DORMA TS73



- For doors of widths: 1.00m weight: 80kg
- For internal and external doors

CODE	DESCRIPTION
TS73	Dorma Doorcloser

## DORMA TS83

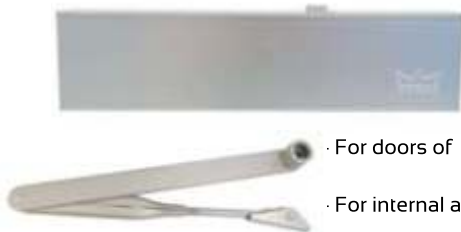

- For doors of widths: 1400mm weight: 120kg
- For internal and external doors

CODE	DESCRIPTION
TS83	Dorma Doorcloser Heavy Duty



- Adjustable closing & Latching speeds
- Non-Handed Installation



CODE	DESCRIPTION
7770-	Union Doorcloser Medium Duty Silver



- For Door Weight 40 - 60 kg
- Adjustable Arm
- Valve for closing speed adjustment
- Valve for final slam adjustment
- Aluminium Finish

CODE	DESCRIPTION
60450-03	Cisa Doorcloser Light Duty

# DIGITAL LOCKS

**BBL Digital Lock**

- Keyless Lock
- Changeable codes
- Deadlocking Latch
- Opens with turn knob from inside



CODE	DESCRIPTION	BARCODE
BBLC100-1	Hold Open Function carded	6009647444233
BBLC101-1	Without Hold Open Function	6009647444158

**BBL Digital Lock**

- Keyless Lock
- Changeable codes
- Deadlocking Latch
- Opens with turn knob from inside



CODE	DESCRIPTION	BARCODE
BBLC200-1	Hold Open Function carded	6009695281729
BBLC201-1	Without Hold Open Function	6009695281736

**BBL Digital Lock**

- Keyless Lock
- Changeable codes
- Deadlocking Latch
- Opens with turn knob from inside



CODE	DESCRIPTION	BARCODE
BBLC100	With Hold Open Function box	6009647444233
BBLC101	Without Hold Open Function box	6009647444158

**ADEL FINGERPRINT & KEYPAD LOCK**



DEADL  
OCKING LA  
TCH

- Single Latch Easy Installation
- High Resolution (500dpi) Optical Sensor
- 3 Ways to Unlock - Fingerprint + Pin  
Pin  
Mechanical Key
- 120 Fingerprint Templates Maximum
- Fingerprint can be Enroled and deleted on the lock

CODE	DESCRIPTION
LA9-3LH	Fingerprint Lockset Left Hand
LA9-3RH	Fingerprint Lockset Right Hand

**ADEL KEYPAD LOCK**



DEADL  
OCKING LA  
TCH

- DIY Design, easy installation
- 32 users - One Master Pin  
31 users' pin
- 2 Mechanical Keys for Emergency
- 4 AA Alkaline Batteries
- 9V External power Supply
- Low Battery Alert
- Stand alone Model

CODE	DESCRIPTION
LA7-3LH	Digital Access Lockset Left Hand
LA7-3RH	Digital Access Lockset Right Hand



5 Year Finnish Warranty

10 Year Mechanical Warranty

Available Keyed Alike and Master Keyed to order

Kwikset Locksets are made from **BRASS** material and are available in a variety of finishes

TYLO



POLO



DEADBOLT

CODE	SIZE	DESCRIPTION
WL170860	60-70mm	Entrance Lock Polo Polished Brass Brass Single Cylinder
WL170909	60-70mm	Entrance Lock Polo Antique Brass Brass Single Cylinder
WL170933	60-70mm	Entrance Lock Polo Satin Chrome Single Cylinder
WL147533	60-70mm	Entrance Lock Tylo Polished Brass Single Cylinder
WL147478	60-70mm	Entrance Lock Tylo Antique Brass Single Cylinder
WL484927	60-70mm	Entrance Lock Tylo Satin Chrome Single Cylinder
WL147524	60-70mm	Privacy Lock Tylo Polished Brass - Bathroom Lock - includes emergency entry key
WL509736	60-70mm	Privacy Lock Tylo Satin Chrome - Bathroom Lock - includes emergency entry key
WL082074	60-70mm	Single Cylinder Deadbolt Polished Brass
WL082155	60-70mm	Single Cylinder Deadbolt Satin Chrome
WL082090	60-70mm	Double Cylinder Deadbolt Polished Brass
WL082171	60-70mm	Double Cylinder Deadbolt Satin Chrome



5 Year Finish Warranty

25 Year Mechanical Warranty

Available Keyed Alike and Master Keyed to order

Kwikset Locksets are made from **BRASS** material and are available in a variety of finishes

HOTEL FUNCTION



BELAIR

CODE	SIZE	DESCRIPTION
WL491642	70mm	Vestibule Set - Hotel Function - Inside always open, Outside unlocked only while key is turned Brass
WL491901	70mm	Vestibule Set - Hotel Function - Inside always open, Outside unlocked only while key is turned Satin CH
WL081981	60-70mm	Privacy Lock Belair Polished Brass - Bathroom Lock - includes emergency entry key
WL489144	60-70mm	Privacy Lock Belair Satin Chrome - Bathroom Lock - includes emergency entry key
WL081957	60-70mm	Entrance Lock Belair Polished Brass Single Cylinder
WL484972	60-70mm	Entrance Lock Belair Satin Chrome Single Cylinder
WL436698	60-70mm	Entrance Lock Belair Polished Brass Key both sides
WL436865	60-70mm	Entrance Lock Belair Satin Chrome Key both sides



**SMART KEY.**



"Bump" resistant technology

ANSI Grade-1 deadbolt rating



Easily re-keyed in seconds

**THE ONLY LOCK YOU CAN RE-KEY YOURSELF**

SmartKey offers a Grade 1 Security Deadbolt in a completely new design - the patented side locking bar technology replaces the traditional pin-&tumbler design which includes BumpGuard for improved security against lock bumping - an attack technique that can defeat conventional pin & tumbler locks. It also provides the flexibility of re-keying your own locks quickly and easily without removing them from the door. Re-key your SmartKey Locks as frequently as you wish while maintaining the highest level of security

**SMART CODE.**



EASY TO INSTALL, PROGRAM AND USE

BACK-LIT KEYPAD FOR INCREASED VISIBILITY

NO MORE WORRYING ABOUT KEYS

**Keyless Entry Deadbolt** - the ultimate in convenience and security  
**One Touch Locking** - with a motorized deadbolt  
**2 Customized access codes** - one code for the family and one code for temporary access  
**Includes SmartKey** - for increased peace of mind

No difficult wiring - uses 4 AA batteries

# BBL KNOBLOCKS



- Opens with key from outside and turn knob from inside
- Fits doors 35-50mm in thickness
- 5-Pin Anti-Pick mechanism
- Deadlocking latch (cannot be opened with credit card)
- Complete with drilling template and fitting instructions



BBK560IPB



BBK562IPB



CODE	SIZE	DESCRIPTION	BARCODE
BBK560IAB	60 - 70mm	Tulip Antique Brass Visi	6009647444387
BBK560IPB	60 - 70mm	Tulip Brass Visi	6009647444332
BK560ISN	60 - 70mm	Tulip Satin Nickle Visi	6009647444349
BBK562IAB	60 - 70mm	Ball Antique Brass Visi	6009695280227
BBK562IPB	60 - 70mm	Ball Brass Visi	6009695280234
BBK562ISN	60 - 70mm	Ball Satin Nickle Visi	6009695280241

# MORTICE LOCKS

**UNION** 2-LEVER  
ASSA ABLOY

- Reversible Latch
- MH Range  
M9H - M32H



CODE	DESCRIPTION	BARCODE
2295-76PL	2 Lever Brass Box	6001843005782
2295-76PL-1	2 Lever Brass Carded	6009695283457
2295-76SS	2 Lever Chrome Box	6001843005812
2295-76SS-1	2 Lever Chrome Carded	6009695283235

**UNION** 3-LEVER  
ASSA ABLOY

- Reversible Latch
- MB Range  
M11B - M54B



CODE	DESCRIPTION	BARCODE
2252-76PL	3 Lever Brass Box	6001843005003
2252-76PL-1	3 Lever Brass Carded	6009695283402
2252-76SS	3 Lever Chrome Box	6001843005034
2252-76SS-1	3 Lever Chrome Carded	6009695283419

**UNION** 4-LEVER  
ASSA ABLOY

- Reversible Latch
- MU Range  
MIU - M36U



CODE	DESCRIPTION	BARCODE
2261-76PL	4 Lever Brass Box	6001843005232
2261PL-1	4 Lever Brass Carded	6009695283426
2261-76SS	4 Lever Chrome Box	6001843005263
2261-76SS-1	4 Lever Chrome Carded	6009695283242

**ESCO** 2-LEVER

- Reversible Latch
- Y Range  
Y1 - Y18



CODE	DESCRIPTION	BARCODE
22311-76BP	2 Lever Brass Box	6001843004600
22311-76BP-1	2 Lever Brass Carded	6009695282788
22311-76SS	2 Lever Chrome Box	6001843004624
22311-76SS-1	2 Lever Chrome Carded	6009695282795

**ESCO** 3-LEVER

- Reversible Latch
- CD Range  
CD1 - CD54



CODE	DESCRIPTION	BARCODE
22312-76PL	3 Lever Brass Box	6001843004655
22312-76PL-1	3 Lever Brass Carded	6009695282801
22312-76SS	3 Lever Chrome Box	6001843004693
22312-76SS-1	3 Lever Chrome Carded	6009695282818

**ESCO** 4-LEVER

- Reversible Latch
- N Range  
N101 - N148



CODE	DESCRIPTION	BARCODE
22313-76PL	4 Lever Brass Box	6001843004723
22313-76PL-1	4 Lever Brass Carded	6009695282825
22313-76SS	4 Lever Chrome Box	6001843004761
22313-76SS-1	4 Lever Chrome Carded	6009695282832

**UNION** 2-LEVER  
ASSA ABLOY

- Reversible Latch
- MH Range  
M9H - M32H



CODE	DESCRIPTION	BARCODE
22959-76BP	2 Lever Brass Box	6009695282184
22959-76BP-1	2 Lever Brass Carded	6009695283563
22959-76CH	2 Lever Chrome Box	6009695289220
22959-76CH-1	2 Lever Chrome Carded	6009695289237

**BBB** 3-LEVER

- Reversible Latch
- MB RANGE  
M11B - M54B



CODE	DESCRIPTION	BARCODE
B2252BP	3 Lever Brass Box	6009695287721

# MORTICE LOCKS

**UNION** 24313-40  
ASSA ABLOY

4 Lever Sliding Claw Lock  
Narrow Style 25mm  
N - Key Range



CODE	DESCRIPTION	BARCODE
24313-40PL	Sliding 4 Lever Brass	
24313-40SS	Sliding 4 Lever SS	6001843006208

**UNION** 24313-76  
ASSA ABLOY

4 Lever Sliding Claw Lock  
Standard 76mm  
N - Key Range



CODE	DESCRIPTION	BARCODE
24313-76PL	Sliding 4 Lever Brass	6001843006284
24313-76SS	Sliding 4 Lever SS	6001843006321

**UNION** 24313-55  
ASSA ABLOY

4 Lever Sliding Wing Lock  
Narrow Style 39mm  
N - Key Range



CODE	DESCRIPTION	BARCODE
24313-55PL	Sliding Narrow Style Brass	6001843134055
24313-55SS	Sliding Narrow Style SS	6001843006246

**UNION** 21320-78  
ASSA ABLOY

3 Lever Deadlock  
Commercial 78mm  
TS181 / R3L Blank



CODE	DESCRIPTION
21320-78PL	Deadlock 78mm Brass
21320-78SS	Deadlock 78mm SS

**UNION** 2157-78  
ASSA ABLOY

3 Lever Deadlock  
Commercial 78mm  
TS181 / R3L Blank



CODE	DESCRIPTION
2157-78PL	Deadlock 78mm Brass
2157-78SS	Deadlock 78mm SS

**UNION** 2277-78  
ASSA ABLOY

3 Lever Heavy Duty  
M101M - M200M  
(new range)  
TS181 / R3L Blank



CODE	DESCRIPTION
2277-78PL	3L Heavy duty MM Key Brass
2277-78SS	3L Heavy duty MM Key SS

**UNION** CYLINDER LOCK  
ASSA ABLOY

Cylinder Mortise  
Excludes Cylinder



CODE	DESCRIPTION	BARCODE
L-22315-76PL	Euro Cyl. Brass	6001843134307
L-22315-76SS	Euro Cyl. SS	6001843134291

**BBL** CYLINDER LOCK

Cylinder Mortise  
Excludes Cylinder



CODE	DESCRIPTION	BARCODE
BBL31576CH	Euro Cyl CH Box	6009680041581
BBL31576CH-I	Euro Cyl CH Carded	6009695282658

# MORTICE LOCKS

**UNION** EMERGENCY EXIT  
ASSA ABLOY

Anti-Thrust Nightlatch 76mm  
Handed Left and Right  
Excludes Cylinder



CODE	DESCRIPTION
L-23318L-76PL	Emergency Exit LH Brass
L-23318L-76SS	Emergency Exit LH SS
L-23318R-76PL	Emergency Exit RH Brass
L-23318R-76PL	Emergency Exit RH SS

**UNION** DRAWBACK LATCH  
ASSA ABLOY

Drawback Latch  
Euro Profile Cylinder  
Excludes Cylinder



CODE	DESCRIPTION	BARCODE
L-23316-76PL	76mm Cyl Lock Brass	6001843134468
L-23316-76SS	76mm Cyl Lock SS	

**UNION** 2332-78  
ASSA ABLOY

78mm Large Oval Cylinder  
Latch Lock  
Excludes Cylinder  
Nightlatch Function



CODE	DESCRIPTION	BARCODE
L-2332-78PL	Large Oval Cyl Lock Brass	6001843134529
L-2332-78SS	Large Oval Cyl Lock SS	

**BBL**

Uses either Large Oval  
or Euro Profile Cylinder  
Fits either Wooden Doors  
or Steel Gates  
Can be used in conjunction  
with Electric Strike  
Excludes Cylinder



CODE	DESCRIPTION	BARCODE
BBL233276SS	Cylinder Latch SS Box	6009680041710
BBL233276SS-1	Cylinder Latch SS Carded	6009680041703

**BBL** 5 LEVER SASH

Key Duplication by Locksmith only  
Anti-Saw Bolts Anti-Pick Curtain  
Brass Bolt & Latch  
Stainless Steel or Solid Brass Face Plate



CODE	DESCRIPTION	BARCODE
BBL5022PB	Mortice 5L Sash Brass	6009647446633
BBL5022SS	Mortice 5L sash SS	6009647446626

**BBL** ROLLER CATCH LOCK

For use on Pivot Doors where  
Pull Handles are used

CODE	DESCRIPTION	BARCODE
BBL51150PB	Mortice Deadbolt & Roller 50mm Brass Box	6009695287653
BBL51150PB-1	Mortice Deadbolt & Roller 50mm Brass Carded	6009695287646
BBL51150SS	Mortice Deadbolt & Roller 50mm SS Box	6009695287660
BBL51150SS-1	Mortice Deadbolt & Roller 50mm SS Carded	6009695287639
BBL51160PB	Mortice Deadbolt & Roller 60mm Brass Box	6009695287509
BBL51160PB-1	Mortice Deadbolt & Roller 60mm Brass Carded	6009695287462
BBL51160SS	Mortice Deadbolt & Roller 60mm SS Box	6009695287455
BBL51160SS-1	Mortice Deadbolt & Roller 60mm SS Carded	

Solid Brass Faceplate  
Solid Brass Bolt  
Adjustable Roller bolt  
Includes Cylinder



# MORTICE LOCKS

**BBL**

Reversible Latch  
 Withdraw Latch by Cylinder  
 Single Throw Deadbolt  
 Suitable for Euro Profile Cylinder



CODE	DESCRIPTION	BARCODE
BBL51255PB-1	Heavy Duty Sash Lock Brass Carded	6009695287516
BBL51255SS-1	Heavy Duty Sash Lock Stainless Steel Carded	6009695287479

**CISA** **BRASS CYLINDER HOOK LOCK WOODEN DOORS**

CODE	DESCRIPTION
45100-35-00	Sliding Door Hook Lock Brass 35mm
45100-35-12	Sliding Door Hook Lock NP 35mm
45100-40-00	Sliding Door Hook Lock Brass 40mm
45100-40-12	Sliding Door Hook Lock NP 40mm
45100-50-00	Sliding Door Hook Lock Brass 50mm
45100-50-12	Sliding Door Hook Lock NP 50mm
45100-60-00	Sliding Door Hook Lock Brass 60mm
45100-60-12	Sliding Door Hook Lock NP 60mm

Brass Faceplates & Strike

Supplied standard with striker, rose set, fixing screws



**CISA** **CYLINDER HOOK LOCK WOODEN DOORS**

CODE	DESCRIPTION
45110-40-00	Sliding Door Hook Lock Brass 35mm
45110-40-12	Sliding Door Hook Lock NP 35mm
45110-50-00	Sliding Door Hook Lock Brass 40mm
45110-50-12	Sliding Door Hook Lock NP 40mm
45110-60-00	Sliding Door Hook Lock Brass 50mm
45110-60-12	Sliding Door Hook Lock NP 50mm

Steel Plated Faceplates & Strike

Supplied standard with striker, rose set, fixing screws



**CISA** **BRASS CYLINDER DEAD LOCK WOODEN DOORS**

CODE	DESCRIPTION
52310-40-00	Dead Lock Euro Double Throw 40mm Brass
52310-40-12	Dead Lock Euro Double Throw 40mm NP Brass
52310-50-00	Dead Lock Euro Double Throw 50mm Brass
52310-50-12	Dead Lock Euro Double Throw 50mm NP Brass
52310-60-00	Dead Lock Euro Double Throw 60mm Brass
52310-60-12	Dead Lock Euro Double Throw 60mm NP Brass
52310-70-00	Dead Lock Euro Double Throw 70mm Brass
52310-70-12	Dead Lock Euro Double Throw 70mm NP Brass

Brass Faceplate & Strike

Double Throw Brass Bolt

Supplied standard with striker, cylinder and all fixing screws

Metal weld-on Box: 523-M

Rebate Kits available:  
 523RB (brass)  
 523RN (nickle)



**CISA** BRASS CYLINDER MORTICE LOCK  
WOODEN DOORS

CODE	DESCRIPTION
5C110-40-00	Double Throw Deadbolt & Latch Brass 40mm
5C110-40-12	Double Throw Deadbolt & Latch Satin Nickle 40mm
5C110-50-00	Double Throw Deadbolt & Latch Brass 50mm
5C110-50-12	Double Throw Deadbolt & Latch Satin Nickle 50mm
5C110-60-00	Double Throw Deadbolt & Latch Brass 60mm
5C110-60-12	Double Throw Deadbolt & Latch Satin Nickle 60mm
5C110-70-00	Double Throw Deadbolt & Latch Brass 70mm
5C110-70-12	Double Throw Deadbolt & Latch Satin Nickle 70mm

Brass Faceplate & Strike

Security for Entrance Doors  
Double-Throw Deadbolt and Latch  
Includes - Cylinder OG300-07  
- Strike Plate

Measure Backset from front of  
faceplate to middle of cylinder



**CISA** BRASS CYLINDER ROLLERBOLT  
WOODEN DOORS

CODE	DESCRIPTION
5C120-40-00	Double Throw Deadbolt & Roller Brass 40mm
5C120-40-12	Double Throw Deadbolt & Roller Satin Nickle 40mm
5C120-50-00	Double Throw Deadbolt & Roller Brass 50mm
5C120-50-12	Double Throw Deadbolt & Roller Satin Nickle 50mm
5C120-60-00	Double Throw Deadbolt & Roller Brass 60mm
5C120-60-12	Double Throw Deadbolt & Roller Satin Nickle 60mm
5C120-70-00	Double Throw Deadbolt & Roller Brass 70mm
5C120-70-12	Double Throw Deadbolt & Roller Satin Nickle 70mm

Brass Faceplate & Strike

Security for Entrance Doors  
Double-Throw Deadbolt and Roller  
Includes - Cylinder OG300-07  
- Strike Plate

Measure Backset from front of  
faceplate to middle of cylinder



**CISA** CYLINDER MORTICE LOCK  
WOODEN DOORS

CODE	DESCRIPTION
5C611-40-00	Double Throw Deadbolt & Latch Brass 40mm
5C611-40-12	Double Throw Deadbolt & Latch Satin Nickle 40mm
5C611-50-00	Double Throw Deadbolt & Latch Brass 50mm
5C611-50-12	Double Throw Deadbolt & Latch Satin Nickle 50mm
5C611-60-00	Double Throw Deadbolt & Latch Brass 60mm
5C611-60-12	Double Throw Deadbolt & Latch Satin Nickle 60mm
5C611-70-00	Double Throw Deadbolt & Latch Brass 70mm
5C611-70-12	Double Throw Deadbolt & Latch Satin Nickle 70mm

Security for Entrance Doors  
Double-Throw Deadbolt and Latch  
Includes - Cylinder OG300-07  
- Strike Plate  
Reversible BICONICAL Latch

Measure Backset from front of  
faceplate to middle of cylinder



**CISA** CYLINDER ROLLERBOLT  
WOODEN DOORS

CODE	DESCRIPTION
5C621-40-00	Double Throw Deadbolt & Roller Brass 40mm
5C621-40-12	Double Throw Deadbolt & Roller Satin Nickle 40mm
5C621-50-00	Double Throw Deadbolt & Roller Brass 50mm
5C621-50-12	Double Throw Deadbolt & Roller Satin Nickle 50mm
5C621-60-00	Double Throw Deadbolt & Roller Brass 60mm
5C621-60-12	Double Throw Deadbolt & Roller Satin Nickle 60mm
5C621-70-00	Double Throw Deadbolt & Roller Brass 70mm
5C621-70-12	Double Throw Deadbolt & Roller Satin Nickle 70mm

Security for Entrance Doors  
Double-Throw Deadbolt and Roller  
Includes - Cylinder OG300-07  
- Strike Plate

Measure Backset from front of  
faceplate to middle of cylinder



### CISA 5 LEVER SASH LOCKS

5 Brass close gate levers with anti-pick device

Yellow powder coated steel case

Reversible Latch

Un-numbered Keys - 500 differs - 02765-00 Keyblank



CODE	DESCRIPTION
52765-57-00	Cisa 5 Lever Sash Lock Brass
52765-57-20	Cisa 5 Lever Sash Lock Stainless Steel

Anodised Aluminium Handles Available - HMKEY

### CISA 3 LEVER SASH LOCKS

3 Brass close gate levers with anti-pick device

Yellow powder coated steel case

Reversible Latch

Un-numbered Keys - 100 differs - 02765-00 Keyblank



CODE	DESCRIPTION
52763-57-00	Cisa 3 Lever Sash Lock Brass
52763-57-20	Cisa 3 Lever Sash Lock Stainless Steel

Anodised Aluminium Handles Available - HMKEY

### CISA CYLINDER SASH LOCKS

Robust construction for high level durability and security

Black powder coated case gives exceptional corrosion resistance

Reversible Latch

Anodised Aluminium Handles Available - HMCYL



HMCYL

Separate forend plate in stainless steel or brass to conceal all fixings and 5200 Series adjustment screw

Robust construction for high lever durability and security

Twist reversible latch without dismantling the lockcase to allow on-site handling

35° follower action for firm positive opening action and with strong follower spring suitable for heavy duty lever furniture

Patented 5200 Series spring adjuster to fine tune the strength without removing the lockcase

Single throw bolt with hardened steel rotating pins to protect the bolt for sawing

The case is pierced to accept bolt through furniture fixings at 38mm centres at the follower and the cylinder position

Dual cylinder capability suitable for euro profile or oval profile cylinders. Supplied as standard with conversion plate for euro profile cylinder applications. For oval cylinders simply remove conversion plate

Black powder case gives exceptional corrosion resistance



Screw 'X'

NB- screw 'x' needs to be replaced after conversion plate is removed

CODE	DESCRIPTION
55210--57-00	Cylinder Sashlock Dead Lock Version Brass
55210--57-20	Cylinder Sashlock Dead Lock Version Stainless Steel
55220-57-00	Cylinder Sashlock Latch & Dead Lock Version Brass
55220-57-20	Cylinder Sashlock Latch & Dead Lock Version Stainless Steel

Rebate Kits Available: 52ORB

**CISA ALUMINIUM DOORS**

Single Throw Deadbolt and Latch  
 NP Brass Faceplate & Strike  
 Available 20mm, 25mm & 35mm  
 backset  
 Recommended Handle: H28SN  
 Latch operated by Key or Handle  
 Supplied with or without cylinder  
 OG300-07-12 (60mm)



CODE	DESCRIPTION
44620	Mortice Latch and Bolt Narrow Style

**CISA ALUMINIUM DOORS**

Single Throw Deadbolt and Latch  
 Available 25mm, 30mm & 35mm  
 backset  
 Recommended Handle: H28SN  
 Stainless Steel 22mm Faceplate  
 Supplied with cylinder OG300-07-12



CODE	DESCRIPTION
46215	Mortice Latch and Swing Bolt

**CISA ALUMINIUM DOORS**

Deadbolt Mortice  
 NP Brass Faceplate & Strike  
 Available 25mm & 35mm backset  
 Supplied with cylinder  
 OG345-05-12 (56mm)



CODE	DESCRIPTION
44640	Narrow Style Deadlock

**CISA ALUMINIUM DOORS**

Deadbolt - Swingbolt Version  
 Available 25mm & 35mm backset  
 Supplied with cylinder OG345-05-12  
 Stainless Steel 22mm Faceplate



CODE	DESCRIPTION
46210	Deadlock Euro Style Swingbolt

**CISA ALUMINIUM DOORS**

Single Throw Deadbolt and  
 Adjustable Roller  
 NP Brass Faceplate & Strike  
 Recommended Handle: H28GN  
 Available 25mm & 35mm backset  
 Supplied with or without cylinder  
 OG300-07-12 (60mm)



CODE	DESCRIPTION
44630	Mortice Roller Catch

**CISA ALUMINIUM DOORS**

Single Throw Deadbolt and  
 Adjustable Roller  
 Available 25mm, 30mm & 35mm  
 backset  
 Supplied with cylinder OG345-05-12  
 Stainless Steel 22mm Faceplate



CODE	DESCRIPTION
46230	Mortice Swing Bolt Roller Catch

**CISA**



CODE	DESCRIPTION
H28SN	Handle Nat Aluminium

**CISA**



CODE	DESCRIPTION
H28GN	Pull Handle Nat Aluminium

**CISA**



CODE	DESCRIPTION
H28GH-Long	Handle Nat Aluminium



**CISA**

Patented Dead Locking Latching Version - Deadlocks upon Closing

Laminated Steel Hook

Locating Pin

Supplied without Cylinder



CODE	DESCRIPTION
45027-16S	Sliding Hook Slam 16mm

**CISA**

Hookbolt Lock - Laminated Steel Hook

Supplied with Cylinder 08210-02-12



CODE	DESCRIPTION
45010-16	Sliding Hook Lock 16mm

**CISA**

Latch Bolt Lock for Steel Gate 30mm Backset

Handed Left and Right

Supplied with Cylinder

Metal Box 421M



CODE	DESCRIPTION
42111-30-1	Latch Lock 30mm Right Hand
42111-30-2	Latch Lock 30mm Left Hand

**CISA**

Latch Bolt Lock for Steel Gate 50mm Backset

Deadbolt Feature Handed Left and Right

Supplied with or without Cylinder

Metal Box 423M



CODE	DESCRIPTION
42311-50-1	Latch Deadlocking 50mm RH
42311-50-2	Latch Deadlocking 50mm LH

**CISA**

Mortice Lock for Metal Doors

Double Throw Deadbolt with Latch

70mm Backset

Supplied with Cylinder



CODE	DESCRIPTION
44151-70	Double Throw Deadbolt Latch 70mm

**CISA**

Mortice Lock for Metal Doors

Double Throw Deadbolt with Rollerbolt

70mm Backset

Supplied with Cylinder



CODE	DESCRIPTION
44161-70	Double Throw Deabolt Rollerbolt 70mm

**CISA**



METAL WELD ON BOX FOR 42111-30 LOCKS

**CISA**



METAL WELD ON BOX FOR 42311-50 LOCKS

# LOCKSETS

**UNION**  
ASSA ABLOY

**LOCKSETS**



CODE	DESCRIPTION	BARCODE
CZ682-24-95CH	2 Lever Lockset MH Key Box	6001843110370
CZ682-24-95CH-1	2 Lever lockset MH Key Carded	6009695283679
CZ682-24-52CH	3 Lever lockset MB Key Box	6001843110271
CZ682-24-52CH-1	3 Lever lockset MB Key Carded	6009695283655
CZ682-24-61CH	4 Lever lockset MU Key Box	6001843110318
CZ682-24-61CH-1	4 Lever lockset MU Key Carded	6009695283662

**ESCO**

**NUTEC LOCKSETS**



CODE	DESCRIPTION	BARCODE
CZ694-24-3113CH	2 Lever Lockset Y Key Box	6003190006962
CZ694-24-3113CH-1	2 Lever Lockset Y Key Carded	6009695283150
CZ694-24-3123CH	3 Lever Lockset CD Key Box	6001843110936
CZ694-24-3123CH-1	3 Lever Lockset CD Key Carded	6009695283167
CZ694-24-3133CH	4 Lever Lockset N Key Box	6003190006986
CZ694-24-3133CH-1	4 Lever Lockset N Key Carded	6009695283174

**ESCO**

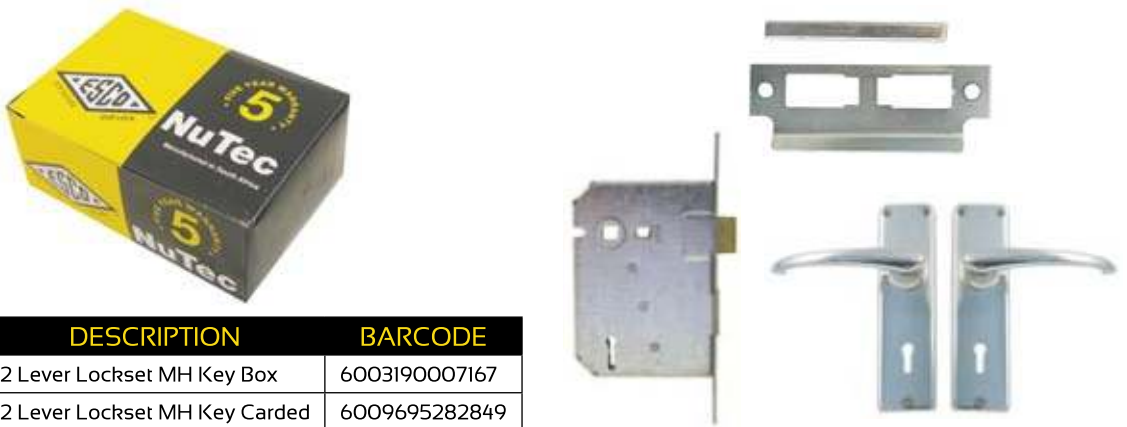

CODE	DESCRIPTION	BARCODE
CZ694-24-853CH	2 Lever Lockset MH Key Box	6003190007167
CZ694-24-853CH-1	2 Lever Lockset MH Key Carded	6009695282849

**ESCO**

**CYLINDER LOCKSETS**



- 2X28NP  
Cylinder included

CODE	DESCRIPTION	BARCODE
CZ694-05-3153CH	Cylinder Lockset Nutec CP Box	6001843110905
CZ694-05-3153CH-1	Cylinder Lockset Nutec CP Carded	6001843110905 3

# LOCKSETS

## BBL LEVER LOCKSETS

SABS Approved  
Lever Locksets

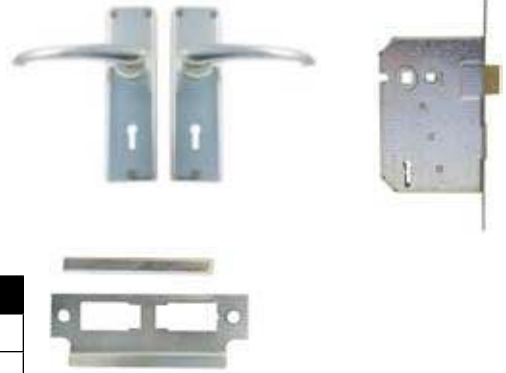

CODE	DESCRIPTION	BARCODE
BLS582-24-52CH	Lockset 2 Lever CH MH Key	6009695288384
BLS582-24-53CH	Lockset 3 Lever CH MB Key	6009695288391
BLS582-24-54CH	Lockset 4 Lever CH MU Key	6009695288407

## BBL CYLINDER LOCKSET



SABS Approved  
Cylinder Lockset

2X28NP Cylinder included



CODE	DESCRIPTION	BARCODE
BLS582-05-222CH	Cylinder Lockset Euro CH	6009695289190

## BBL

Blank Available : BB111

For use on external doors where  
low level of security is required

Fits Left or Right hinged doors



CODE	DESCRIPTION	BARCODE
ED-111	Rim Lockset	6009695282207

## UNION ASSA ABLOY



PX5248

CODE	DESCRIPTION	BARCODE
PX5248	Rim Lock Furniture Boxed	6001843016306
PX5248-1	Rim Lock Furniture Carded	6009695283815

## UNION ASSA ABLOY

RC Key Range



CODE	DESCRIPTION	BARCODE
1448-5248PX2	Rim Lockset Box	60018430023310
1448-5248PX2-1	Rim Lockset Carded	

## Yale

RC Key Range

For use on external doors where  
low level of security is required

Fits Left or Right hinged doors



CODE	DESCRIPTION	BARCODE
DY1448-5248PX2	Rim Lockset	6003190006689

# LOCKSETS



## MULTI-LEVER LOCKSETS

Budget Lockset for internal use

Blanks Available for duplicating of keys - BB222



CODE	DESCRIPTION	BARCODE
ED-222	Multilever Lockset	6009695282191

# REBATES

**UNION** LIGHT DUTY REBATE  
ASSA ABLOY

CODE	DESCRIPTION
2700PL	For 2L, 3L, 4L light duty Union Locks Brass
2700SS	For 2L, 3L, 4L light duty Union Locks SS

**UNION** HEAVY DUTY REBATE  
ASSA ABLOY

CODE	DESCRIPTION
2900PL	For Heavy Duty 3 L and Cylinder Locks Brass
2900SS	For Heavy Duty 3 L and Cylinder Locks SS

**CISA**

CODE	DESCRIPTION
120RB	Rebate for Cisa 12016 Lock Brass
120RN	Rebate for Cisa 12016 Lock Nickle

**CISA**

CODE	DESCRIPTION
521RB	Rebate for Cisa 52110 Lock Brass
521RN	Rebate for Cisa 52110 Lock Brass

**CISA**

CODE	DESCRIPTION
523RB	Rebate for Cisa 52310 Lock Brass
523RN	Rebate for Cisa 52310 Lock Brass

**CISA**

CODE	DESCRIPTION
551RB	Rebate for 55220-57 Brass
551RN	Rebate for 55220-57 Nickle

# GARAGE LOCKS

**UNION**  
ASSA ABLOY



CODE	DESCRIPTION
LE2022R	RO2 Roll-Up Chrome Plated Drilled

**UNION**  
ASSA ABLOY



CODE	DESCRIPTION
LE2203R	RO2 Roll-Up Chrome Plated Studded

**UNION**  
ASSA ABLOY



CODE	DESCRIPTION
LE1111R	RO6 Roll-Up Chrome Plated

**UNION**  
ASSA ABLOY



CODE	DESCRIPTION
LA7313R	Roll-Up Barrel and Arms Chrome Plated

**UNION**  
ASSA ABLOY



CODE	DESCRIPTION
LE2322R	Wispeco Roll-Up Chrome Plated

**BBL**



CODE	DESCRIPTION
BBLRO1	Garage Lock ROI Boxed
BBLRO1-1	Garage Lock ROI Carded

**FIRST LOCK**



CODE	DESCRIPTION
FL5941037SAC	Roll-Up RO2 Complete

**FIRST LOCK**

Zinc Case and Steel Cover  
Length: 115mm  
Width: 60mm



CODE	DESCRIPTION
FL5940032	Roll-Up ROI Garage N/Style

# T-HANDLES

**UNION**  
ASSA ABLOY



CODE	DESCRIPTION
LM3503	T-Handle Threaded 100mm Right Hand

**UNION**  
ASSA ABLOY



CODE	DESCRIPTION
LM3504	T-Handle Threaded 100mm Left Hand

**Yale**

Die Cast zinc and Chrome Plated.

Ideal for use on Garage Doors and Vehicle Canopies



CODE	DESCRIPTION
UDY3475	T-Handle Concealed Fixing

**FIRST LOCK**

Countersunk Hole Chrome Plated



CODE	DESCRIPTION
FL16385189LE	T-Handle Threaded Left Hand
FL16385189RE	T-Handle Threaded Right Hand

**FIRST LOCK**

Countersunk Hole Black Plated



CODE	DESCRIPTION
FL16385385	T-Handle Black Threaded Spindle 120mm

**FIRST LOCK**

Countersunk Hole Black Plated



CODE	DESCRIPTION
FL16385187	T-Handle Black Plain Spindle 120mm

**FIRST LOCK**

Countersunk Hole Chrome Plated



CODE	DESCRIPTION
FL16385127	T-Handle Chrome Plain Spindle 120mm

**FIRST LOCK**

Concealed Fixing Chrome Plated



CODE	DESCRIPTION
FL16175125	T-Handle Chrome Plain Spindle 120mm

# L-HANDLES

**UNION**  
ASSA ABLOY



CODE	DESCRIPTION
LL1760	L-Handle Drilled Plain Spindle 75mm

**UNION**  
ASSA ABLOY



CODE	DESCRIPTION
LL1762	L-Handle Studed Plain Spindle 75mm

**UNION**  
ASSA ABLOY



CODE	DESCRIPTION
LL1763	L-Handle Drilled Threaded Spindle 110mm

**UNION**  
ASSA ABLOY



CODE	DESCRIPTION
LL1764	L-Handle Studed Threaded Spindle 110mm

**UNION**  
ASSA ABLOY



CODE	DESCRIPTION
LL4002	L-Handle Studed Spindle 45mm 180 P/S

**FIRST LOCK**

Chrome Plated  
Complete with 3 point Cam



CODE	DESCRIPTION
FL16025226	L-Handle Studed Spindle 20mm

**FIRST LOCK**



CODE	DESCRIPTION
FL16020005	Dummy L - Handle

**UNION**  
ASSA ABLOY

**FLUSH FITTING HANDLE**





CODE	DESCRIPTION
LN1109	Flush Fitting Handle Laudon

# ELECTRIC LOCKS & ACCESSORIES







## ELECTRIC STRIKE SET

Includes Easy to Install Instructions  
 Included in Set: Transformer (wire or plug-in)  
 Adjustable Strike  
 15mm Latch Lock  
 Small Oval Cylinder  
 Push Button

CODE	DESCRIPTION	BARCODE
BBE-11W	Electrical combo Set Wire Transformer	6009695280609
BBE-22P	Electrical combo Set Plug-In Transformer	6009695280609







BBT1
BBT2
RE-135

CODE	DESCRIPTION	BARCODE
RE-135	Push Button boxed	6009647441928
RE-135-1	Push Button carded	6009695283969
BBT1	Wire Transformer 12V 1.2A boxed	6009647441911
BBT1-1	Wire Transformer 12V 1.2A BBL card	6009695282689
BBT2	Plug-In Transformer 16V 1A Box	6009647443748
BBT2-1	Plug-In Transformer 16V 1A BBL card	6009695282696



## TUBULAR KEYSWITCH



CODE	DESCRIPTION
SDY3315SPL	1 position Pullout 2 Term Spring
SDY3315L-2	ON/OFF 2 Position Pullout
SDY3319L-2	ON / OFF 3 Position Pullout 4 Terminals
SDY3313L-2	Small ON/OFF 2 Position Pullout 2 Terminals

Double 60mm Cylinder  
 Reversible Latch  
 12V DC Power Supply



CODE	DESCRIPTION
CE-109	Electric Motorized Rim Lock Double Cylinder

Single 60mm Cylinder  
 Reversible Latch  
 12V DC Power Supply  
 Mechanical Opening Knob  
 Push Button for Electrical Opening



CODE	DESCRIPTION
CE-104	Electric Motorized Rim Lock Single Cylinder



# ELECTRIC LOCKS & ACCESSORIES



**Single Pulse** = When the Button has been pushed the Gate Opens and remains open.  
**Continuous Pulse** = the Button must held in to allow the Gate to be opened. The Gate will remain locked if the Gate is not opened.

CODE	DESCRIPTION	BARCODE
2200IB	Mortise Single Pulse Box	6009695280029
2200IB-1	Mortise Single Pulse Carded	6009695283181
22084B	Surface Mount Single Pulse	6009695280722
22084B-1	Surface Mount Single Pulse Card	6009695283198
2210IB	Mortise Adjustable Continuous Pulse Box	6009695280692



2200IB



## ELECTRIC STRIKE JIS

Single Pulse Electric Strike  
Adjustable Backset



CODE	DESCRIPTION
832-90IG	Single Pulse Adjustable Box
832-90IG-1	Single Pulse Adjustable Carded



Single Pulse Electric Strike  
Fail Secure  
With Faceplate Silver or Brass  
Reversible  
12V AC/DC 12 ohm  
Stainless Steel Faceplate  
Suitable for series locks:  
44600 52110 52611



CODE	DESCRIPTION
15001-10-00	Electric Strike Single Pulse Silver
15001-10-BR	Electric Strike Single Pulse Brass



Single Pulse Electric Strike  
Fail Secure Hold-Open Mechanism  
Suitable for Lock Series: 54315

CODE	DESCRIPTION
15006-10-00	Electric Strike Single Pulse



Continuous Pulse Electric Strike  
Fail Secure  
Reversible  
Stainless Steel Faceplate



CODE	DESCRIPTION
15005-20-00	Electric Strike Cont. Pulse Silver
15005-20-BR	Electric Strike Cont. Pulse Brass



Single Pulse Electric Strike  
With Hold-Open Mechanism  
Fail Secure Reversible  
Stainless Steel Faceplate Strike



CODE	DESCRIPTION
15005-10-00	Electric Strike Single Pulse Silver
15005-10-BR	Electric Strike Single Pulse Brass



Single Pulse Electric Strike Heavy Duty  
Fail Secure  
With Faceplate Silver or Brass  
Handed Left and Right  
12V DC 70 ohm



CODE	DESCRIPTION
15060-10-1	Single Pulse Fail Secure Right Hand
15060-10-2	Single Pulse Fail Secure Left Hand

# ELECTRIC LOCKS & ACCESSORIES

eff eff

Grey Faceplate  
Standard - Power to Unlock



CODE	DESCRIPTION
15CA5499	12Vdc 10mm Latch Depth

eff eff

Continuous Pulse  
Standard - Power to Unlock  
Suitable for metal doors



CODE	DESCRIPTION
14KL-GY	12Vdc Grey Faceplate
14KL-SS	12Vdc Stainless Steel Faceplate

eff eff

Suitable for Metal Door Frames  
Faceplate Length 130mm  
Continuous Pulse



CODE	DESCRIPTION
17KL-GY	12Vdc Grey Faceplate Standard
17KLSS	12Vdc SS Faceplate Standard
34KL-GY	12Vdc Grey Faceplate Reverse Action
34KL-SS	12Vdc SS Faceplate Reverse Action

eff eff

Stainless Steel Faceplate  
Standard - Power to Unlock  
Continuous Pulse



CODE	DESCRIPTION
AL76-17L	12Vdc Timber Door Frame Long Face
AL76-17S	12Vdc Metal Door Frame Short Face

## TEL 530/1 Electromechanical Lock

The TEL530/1 Electromechanical Lock is controlled via the access control system in one of two ways

- > The outside handle is electrically controlled by an access control device, such as a key pad or card reader. The inside handle always allows free exit
- > Both handles require access control input to operate

**The lock provides monitoring for:**

- > External handle operation
- > Deadbolt (locked or unlocked)
- > Cylinder turned
- > Sabotage

**Application:**

- > Typical application access control for commercial building e.g. office doors where aesthetics are a priority



## DIAGRAM TO DETERMINE DOOR HAND

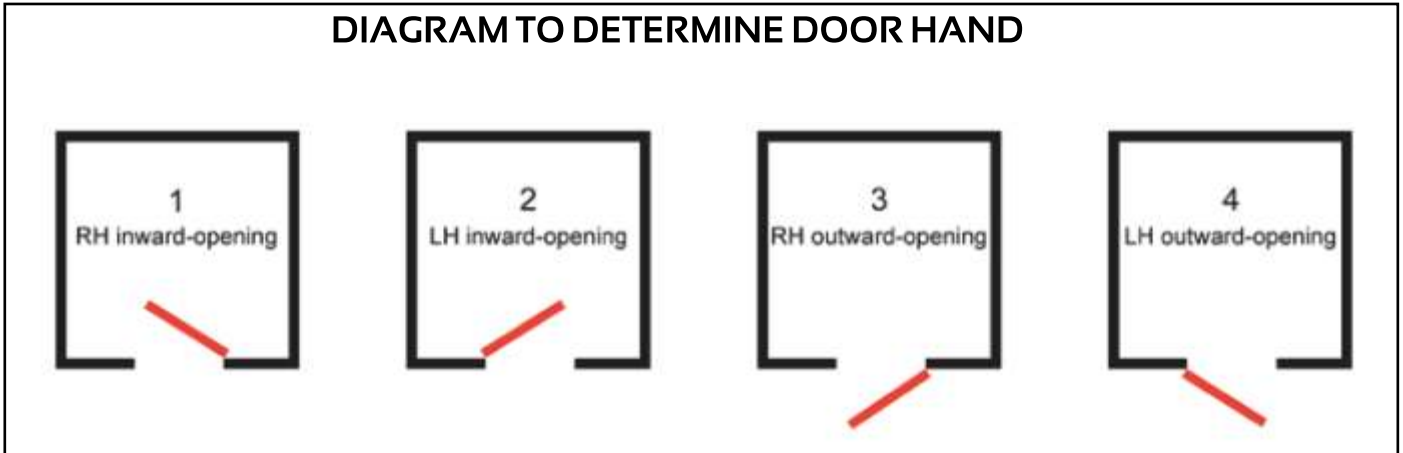

**CISA 11721-60 STEEL GATES**



CODE	DESCRIPTION
11721-60-1	Right Hand <b>Inward</b> Opening No Button
11721-60-2	Left Hand <b>Inward</b> Opening No Button

**CISA 11921-60 STEEL GATES**



CODE	DESCRIPTION
11921-60-3	Right Hand <b>Outward</b> Opening No Button
11921-60-4	Left Hand <b>Outward</b> Opening No Button

**CISA 11731-60 STEEL GATES**



CODE	DESCRIPTION
11731-60-1	Right Hand <b>Inward</b> Opening With Button
11731-60-2	Left Hand <b>Inward</b> Opening With Button

**CISA 11931-60 STEEL GATES**



CODE	DESCRIPTION
11931-60-3	Right Hand <b>Outward</b> Opening With Button
11931-60-4	Left Hand <b>Outward</b> Opening With Button

**CISA 1A721 STEEL GATES**



Withstands force of 2000kg  
Lasts more than 1 million cycles

CODE	DESCRIPTION
1A721	Elettrika without Button
1A721-SP	Elettrika without button SP Cylinder

**CISA 1A731 STEEL GATES**



Withstands force of 2000kg  
Lasts more than 1 million cycles

CODE	DESCRIPTION
1A731	Elettrika with Button
1A731-SP	Elettrika with Button SP Cylinder



**CISA**

Midrail Type Dead Locking Latch

Cylinder O8210-02-12

CODE	DESCRIPTION
14511-70	Mortice Electric Lock Midrail 70mm



**CISA**

Cylinder O8545-05-12

143RB & 143RN Rebate Kit Available

CODE	DESCRIPTION
14351-70	Mortice Elec Lock Euro Cylinder 70mm



**CISA**

Double Throw Deadbolt & Latch

Available 70mm backset

Supplied with cylinder O8210-02-12

Handed Left and Right

CODE	DESCRIPTION
14461-70	Electric Lock Mortice Midrail



**CISA**

Narrow Style Dead Locking Latch

Available 15mm & 18mm backset

Supplied with cylinder O8210-02-12

Suitable for Steel Pedestrian Gates and Metal Doors

Operation by Key or Remote

CODE	DESCRIPTION
14021-15-1	Electric Lock Mortice Right Hand 15mm
14021-15-2	Electric Lock Mortice Left Hand 15mm
14021-18-1	Electric Lock Mortice Right Hand 18mm
14021-18-2	Electric Lock Mortice Left Hand 18mm



**CISA**

Adjustable Latch

Narrow Style Gate Lock with Stainless Steel Faceplate & Strike

Suitable for uPVC, Aluminium and other metal doors

Cylinder OG345-05-12

Latch Only

Recommended Handles H28GH-LONG

CODE	DESCRIPTION
16205-25	Electric Lock Mortice Latch Only 25mm
16205-35	Electric Lock Mortice Latch Only 35mm



**CISA**

Adjustable Latch

Narrow Style Gate Lock with Stainless Steel Faceplate & Strike

Suitable for uPVC, Aluminium and other metal doors

Cylinder OG345-05-12

Latch and Swing Bolt

Optional with Saw Resistant Bolt

Recommended Handles H28GH-LONG

CODE	DESCRIPTION
16215-25	Electric Lock Mortice Swing Bolt & Latch 25mm
16215-35	Electric Lock Mortice Swing Bolt & Latch 35mm



Elettrika for Wooden Door  
Cylinder OG500

CODE	DESCRIPTION
1A610	Rim Elettrika Wooden Doors Inner Push Button



Elettrika for Wooden Door - Hold Open Device  
Cylinder OG115 Cylinder Deadlock Button

CODE	DESCRIPTION
1A630	Rim Elettrika Wooden Doors Inner Push Button



**BRASS CISA MORTICE ELECTRIC LOCK 12016**

Double Throw Dead Bolt with Latch operation by remote control or key

CODE	SIZE	DESCRIPTION
12016-40	40mm	Elec Mortice Brass
12016-40-12	40mm	Elec Mortice Chrome
12016-50	50mm	Elec Mortice Brass
12016-50-12	50mm	Elec Mortice Chrome
12016-60	60mm	Elec Mortice Brass
12016-60-12	60mm	Elec Mortice Chrome
12016-70	70mm	Elec Mortice Brass

Brass Faceplate & Strike

Rebate Kit Available:  
12ORB (brass) 12ORN (nickle)

Optional inside Mechanical Button O6110



**RIM LOCK FOR WOODEN DOORS**



Inside Push Button Only

CODE	DESCRIPTION
11610-60-1	Electric Rim Lock for Wooden Door Right Hand
11610-60-2	Electric Rim Lock for Wooden Door Left Hand



**RIM LOCK FOR WOODEN DOORS**



Inside Push Button & Cylinder

CODE	DESCRIPTION
11630-60-1	Electric Rim Lock for Wooden Door Right Hand
11630-60-2	Electric Rim Lock for Wooden Door Left Hand



CODE	DESCRIPTION
TF12P3	Transformer 3AMP 12VAC
TF12P	Transformer 1.5AMP 12VAC



**Booster Plus**

- Voltage Adaptor (when other than 12Vac)
- Electric hold Open
- Opening Command Timing (5 settings)
- State of Door Signal
- Input when Power Reduced

CODE	DESCRIPTION
07022-10	Booster Plus - Coil set for Elektrica 1A721



Coil for Elekrika Locks:

- 1A721
- 1A731
- 1A610
- 1A630

CODE	DESCRIPTION
07025-00	Coil for Elekrika



12 volt coil Set for:

- 14021-15-1
- 14021-15-2
- 14021-18-1
- 14021-18-2

Available in 24V AC

CODE	DESCRIPTION
07047-00	Coil for 14021 12 Volt



Coil for:

- 11610
- 11631
- 11721
- 11731
- 11921
- 11931

Coils are handed left & right according to the lock.  
Available in 24V AC

CODE	DESCRIPTION
07120-1	Coil Adjustable 12V Right Hand
07120-2	Coil Adjustable 12V Left Hand



**Booster**

To adapt:  
12Vdc - 24Vdc - 24Vac

Booster guarantees sufficient power supply to a lock.

For Elektrica 1A721

CODE	DESCRIPTION
07022-00-00	Transformer Power Booster



24 Volt coil set for 12016 Locks

CODE	DESCRIPTION
07009-00	Coil for 12016 12V
07009-01	Coil for 12016 24V



Accessories for Aluminium Door Locks - Nylon Contact Set - for 12016 Locks

CODE	DESCRIPTION
06510	Contact Set Nylon

# LOCKSMITH TOOLS

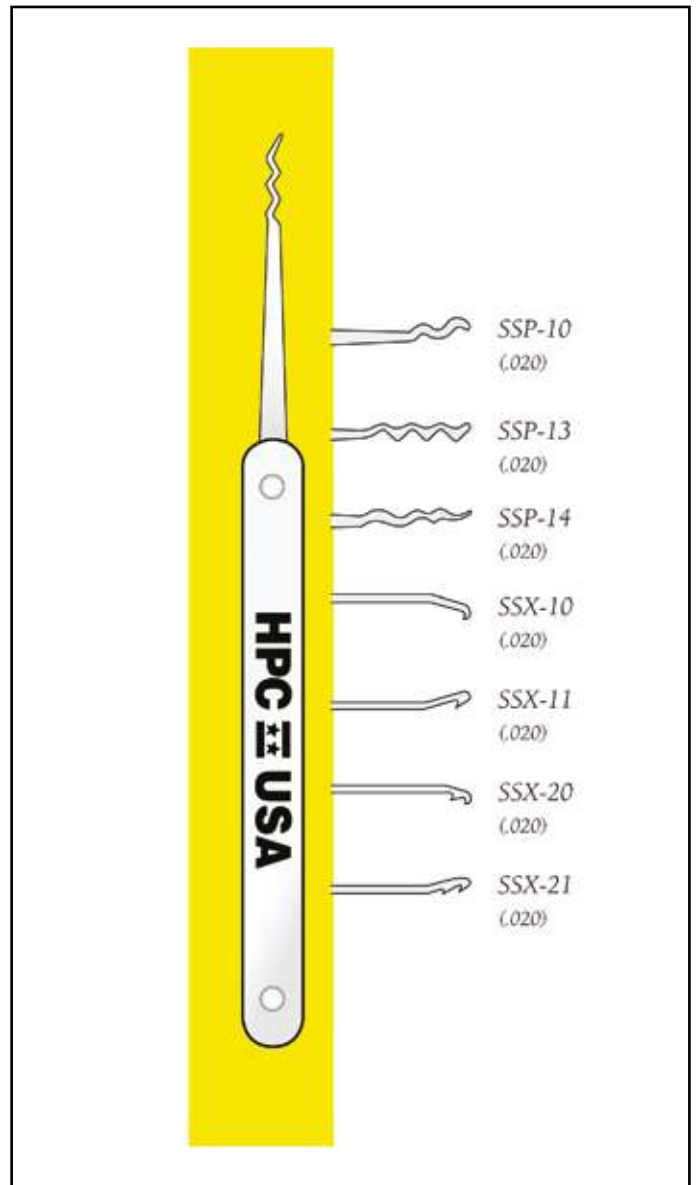
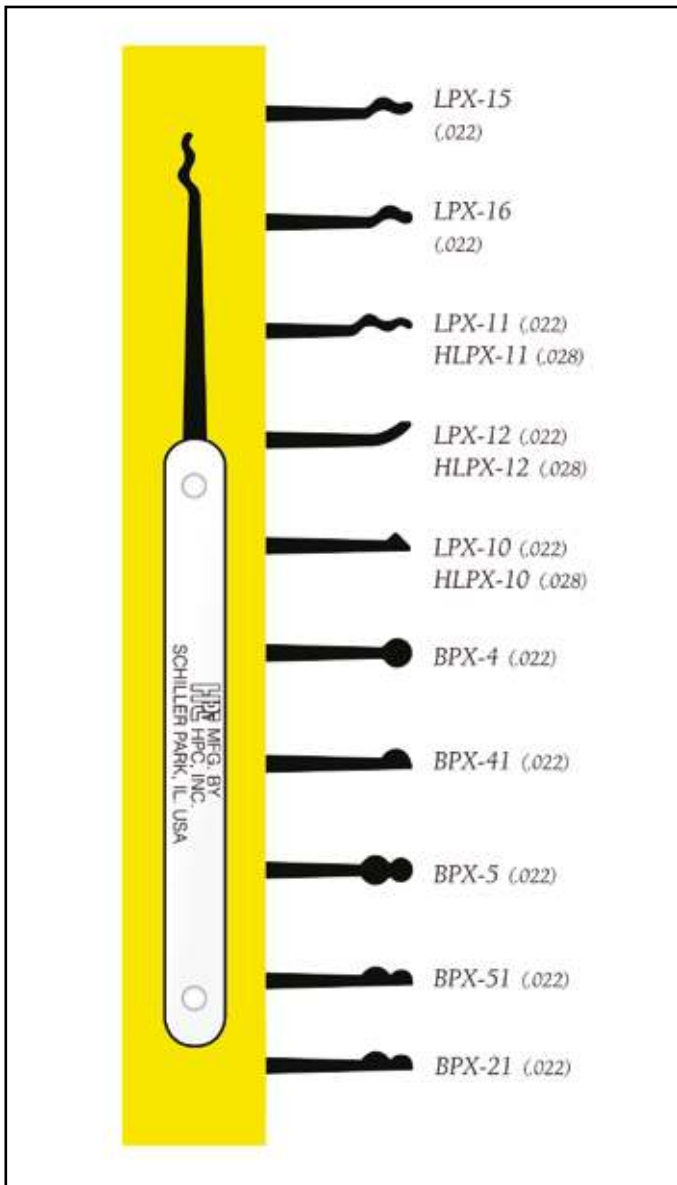

**BALLS** - are used for raking and are available in different patterns



**DIAMONDS** - are used for picking or raking. They are especially effective on locks with wafer tumblers



**EXTRACTOR** - are used to retrieve broken keys or other matter from inside the lock.



**HOOKS** - are used for actual picking 1 chamber at a time ( as opposed to raking) They are particularly useful when the lengths of the bottom pins are significantly different



**RAKES** - are used for raking (manipulating pins in all of the chambers at the same time)

# LOCKSMITH TOOLS

## HPC

### LIGHT TENSION



### MEDIUM TENSION

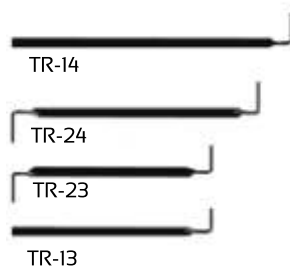

### RIGID TENSION

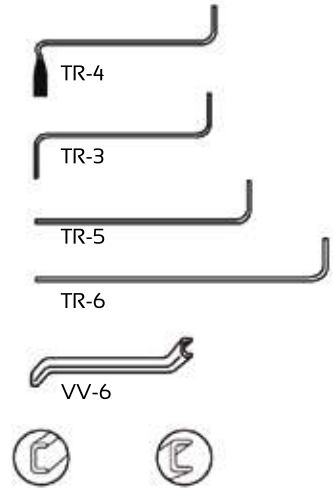

Proper tension is the key to picking and raking locks. Whether your tool of choice is a hook, diamond, ball or rake the lock will not open without just the right amount of tension applied to the cylinder.. HPC manufacture a wide variety of tension tools.

CODE	DESCRIPTION
TR-9	Double-Sided Twist 13.35cm
TR-12	Single-Sided Twist 11.45cm
TR-7	Double-Sided Twist 8.25cm
TR-14	Single-Sided Twist 11.45cm
TR-24	Double-Sided Twist 10.15cm
TR-23	Double-Sided Twist 8.25cm

CODE	DESCRIPTION
TR-13	Single-Sided Twist 8.25cm
TR-4	Twist & Straight 5.70cm
TR-3	Double-Sided Straight 7.00cm
TR-5	Single-Sided Straight 5.70cm
TR-6	Single-Sided Straight 9.50cm
VV-6	Double-Sided Grooved 5.08cm

## TENSION TOOLS FOR TULIP-SHAPED KNOBS



CODE	DESCRIPTION
TR-2	Medium Tension
TR-22	Rigid Tension

## DOUBLE-SIDED TENSION TOOLS

These tension tools are used on double-sided locks



CODE	DESCRIPTION
TEN-7	Zinc Plated Medium Tension
TEN-9	Black Rigid Tension

## VARIABLE-SIZE TENSION TOOLS

The tips of these tension tools can be compressed to fit into keyways of various sizes



CODE	DESCRIPTION
STW-3	For standard locks - automotive & door locks
STW-4	Specially designed for tulip-shaped door knobs

## HANDS-FREE TENSION TOOL KIT

Takes the difficulty out of picking - includes hands-free tension tool and a matching 2-sided rake/diamond pick. The tension tool and picking tools clip together.



CODE	DESCRIPTION
HFTT-KIT	Tension Tool Kit - Hands Free



# LOCKSMITH TOOLS

**HPC**

Spring-controlled tension. Large prongs make it excellent for automotive use.



TNT-21

CODE	DESCRIPTION
TNT-21	Spring Loaded Adjustable Prong

**HPC**



PTT-4  
15.25cm

PTT-5  
11.5cm

CODE	DESCRIPTION
PTT-4	Pin Tumbler Tweezer, provides firm, non-twist grip
PTT-5	Compact Pin Tumbler Tweezer, grips top & bottom pins

**HPC**

Makes it easier to load top pins into cylinder. While top pin is held in place, use forefinger to push the attachment down to set the pin into the chamber. The pin loading wire is easily removable, making this ideal for lading bottom pins as well.



TPT-5  
15.25cm

CODE	DESCRIPTION
TPT-5	Pin tumbler Tweezer with Pin Pushing Attachment

**HPC**



ALCP-10

The Auto Lock Cap Pliers remove auto lock face caps easily. The specially machined tips grip like a vice. When used with care, auto caps can be removed with minimum of distortion allowing re-use of the removed cap.

CODE	DESCRIPTION
ALCP-10	HPC Cap removal pliers

**HPC**



Revolutionary tool that acts as a third hand to hold open the dust cover on auto door locks. This allows you to have both hands free to pick the lock or extract a broken key.

CODE	DESCRIPTION
GTO	HPC Gateway™ Tool

**HPC**

For installing cam locks on metal cabinets, desks, filing cabinets and cash boxes.



Punches 16.4mm x 19.5mm hole in 1.2mm mild steel

CODE	DESCRIPTION
HDPS-4	HPC Metal Punch and Die set.

**HPC**

An inexpensive set of gauges that eliminates the guesswork when reading the tumblers on 6-cut single sided GM keys.



CODE	DESCRIPTION
GMTD-5	HPC GM Tumbler Decoder Gauge

**HPC**

Designed for the swift removal of the side-bar on 1984 -1996 Ford cars. After drilling the side bar, the ignition can be easily removed.



CODE	DESCRIPTION
ITF-14	HPC Ford Ignition Drill Template

# LOCKSMITH TOOLS

## HPC PIP-13

Assortment of 7 spring steel hooks, diamonds, rakes and balls.  
3 Tension Tools  
1 Extractor  
Genuine Leather Case



CODE	DESCRIPTION
PIP-13	Pickset HPC 11 Piece

## HPC PIP-15

Assortment of 6 spring steel hooks, diamonds, rakes and balls.  
2 Tension Tools  
1 Extractor  
Genuine Leather Case



CODE	DESCRIPTION
PIP-15	Pickset HPC 9 Piece

## HPC PIP-23

Assortment of spring steel hooks, diamonds, rakes and balls.  
Tension Tools Extractor  
Genuine Leather Case including ID Badge



CODE	DESCRIPTION
PIP-23	Pickset HPC 14 Piece

## HPC PIP-2000

Assortment of 9 stainless steel hooks, diamonds, rakes and balls.  
3 Tension Tools  
4 Stainless Steel Extractors  
Genuine Leather Case



CODE	DESCRIPTION
PIP-2000	Pickset HPC 16 Piece Stainless Steel

## HPC NDPK-16

Assortment of 10 spring steel hooks, diamonds, rakes and balls.  
4 Tension Tools  
2 Extractors  
Genuine Leather Case



CODE	DESCRIPTION
NDPK-16	Pickset HPC Deluxe 16 Piece

## HPC NDPK-24

Assortment of 14 spring steel hooks, diamonds, rakes and balls.  
5 Tension Tools  
5 Extractors  
Genuine Leather Case



CODE	DESCRIPTION
NDPK-24	Pickset HPC Pro Mixer 24 Piece

## HPC NDPK-32

Assortment of 22 spring steel hooks, diamonds, rakes and balls.  
7 Tension Tools  
3 Extractors  
Genuine Leather Case



CODE	DESCRIPTION
NDPK-32	Pickset HPC Superior 32 Piece

## HPC

Assortment of 10 spring steel hooks, diamonds, rakes and balls.  
4 Tension Tools  
2 Extractors & The Pocket Jim Car Opener  
Genuine Leather Case



AKK-P17

CODE	DESCRIPTION
AKK-P17	Pocket Killer Kit 17 Piece

# LOCKSMITH TOOLS



CO-10



CO-20



CO-24



CO-55



CO-72



CO-73



CO-76



CO-75

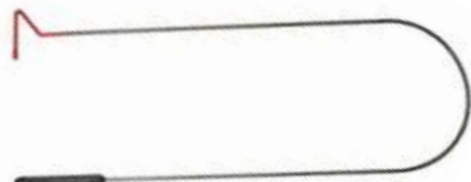

CO-80

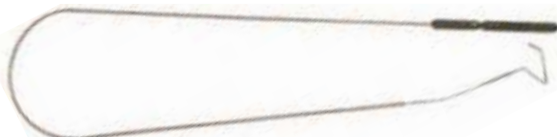

CO-83



CO-11

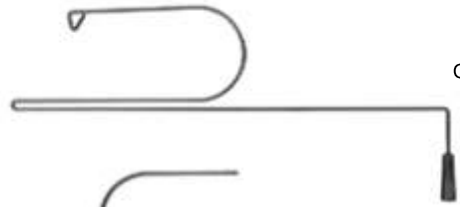

CO-70



CO-22



CO-78



CO-79



CO-81



CO-85



CO-39

CODE	DESCRIPTION
CO-10	Original Slim Jim HPC Car Opener
CO-11	Super Slim Jim - wider version
CO-20	Peg Leg Jim - for models with protected linkage
CO-22	Slim Jim Dandy Car Opener
CO-24	Ultra Jim - Flexible - ability to custom bend
CO-39	Horizontal Hook - binds horizontal rods
CO-55	Big Jim - extended length
CO-70	Super Killer - extra length, tallest and widest arc
CO-72	Short Double "L"- laminated slip resistant coating

CODE	DESCRIPTION
CO-73	Lasso - high quality "poly-flex" material
CO-75	Horizontal Clutch™ - Horizontal Rod Style
CO-76	Vertical Clutch™ - Vertical Rod Style
CO-78	Twin Hooks - Through Car Style, grabs door handles
CO-79	Instant Explorer Tool - To open Ford Explorers
CO-80	Switch Stick - Bendable long reach with unique hook
CO-81	Thru Car Clutch™ - For hooking inside door handle
CO-83	Fishing Pole - Curves and flexes up to 90°
CO-85	Twin Hooks - Double hook end that opens and closes

# LOCKSMITH TOOLS

## HPC



CODE	DESCRIPTION
AW-34	Ultimate Auto Wedge 19mm max thickness
AW-38	Ultimate Auto Wedge 9.5mm max thickness
PW-100	Power Wedge - spring loaded compound lever
AW-99	Air Wedge HPC Original Small
AW-100	Air Wedge HPC Original Large

## GOSO

THE ORIGINAL

**KLOM**

AIR WEDGE



GOP-BO7SML

GOP-BO7MED

GOP-BO7LRG

CODE	DESCRIPTION
GOP-BO7SML	Air Wedge GOSO Small
GOP-BO7MED	Air Wedge GOSO Medium
GOP-BO7LRG	Air Wedge GOSO Large

## DINO

RGN227 - 15.8cm (W) x 14.3cm (H)

RGN228 - 11.377cm (W) x 12.4cm (H)



CODE	DESCRIPTION
RGN227	Air Wedge DINO Small
RGN228	Air Wedge DINO Large

## DINO

RGN210 - with enclosed hard plastic sheet easier to slide and insert

RGN208 - double pillow easier to insert opening wire



RGN210



RGN208

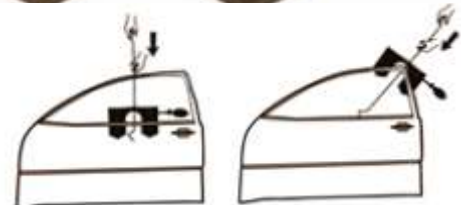

CODE	DESCRIPTION
RGN210	Air Fighter DINO Small
RGN208	Air Fighter DINO Small

# LOCKSMITH TOOLS

## HPC



AKK-55



AKK-66



AKK-88



AKK-99

CODE	DESCRIPTION
AKK-55	Starter Killer Kit - CO-11 CO-22 CO-39 CO-61 (2)AW-38 AKK-INS55 AKK-POUCH
AKK-66	Pro Killer Kit - CO-11 CO-22 CO-39 CO-61 (2)AW-34 (2)AW-38 FAL-15 AKK-INS66 AKK-POUCH
AKK-88	Classic Killer Kit - CO-6 CO-10 CO-11 CO-18 CO-22 CO-39 CO-55 CO-59 CO-60 CO-61 CO-70 (2)AW-34 (2)AW-38 FAL-15 AKK-INS88 AKK-CASE
AKK-99	Ultimate Killer Kit - CO-6 CO-10 CO-11 CO-18 CO-22 CO-39 CO-55 CO-59 CO-60 CO-61 CO-68 CO-70 CO-71 CO-72 CO-73 CO-79 (2)AW-34 (2)AW-38 FAL-15 PIP-13 AKK-INS99 COA-CD AKK-CASE

### HPC TUBULAR PICK

Compact and Economical tubular pick. Several effective features. Includes tubular key decoder.



CODE	DESCRIPTION
TLP-PEANUT	HPC tubular pick - Peanut

### HPC TUBULAR PICK

Minute adjustments possible on tension of feelers. Includes Tubular Key Decoder. Genuine Leather Case



CODE	DESCRIPTION
TLP-CMOD-B	HPC Tubular Pick Adjustable Collar

### HPC TUBULAR PICK & PICK DECODER

Stainless Steel measuring device for decoding tubular keys and picks.



CODE	DESCRIPTION
TKPD-1	Tubular key and pick decoder

### HPC PICK GUN

Designed to easily rake open pin and disc tumbler locks. Rapid squeezing of the trigger bounces the pick needle, raising the pins or discs to the shear line. Includes 3 pick blades and 2 tension wrenches.



CODE	DESCRIPTION
HPG-10	HPC Pick Gun

# LOCKSMITH TOOLS

## SOUBER TOOLS



CODE	DESCRIPTION
LP-1	Set of 12 Picks Spring Steel Suit most Lever Locks
LP-2	Set of 20 Picks Spring Steel Suit most Lever Locks

## SOUBER TOOLS

Suits both Euro & Oval Cylinders.  
Cylinders need to project few mm to work.  
Zinc plated and painted.

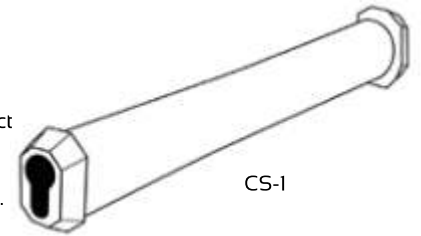

CODE	DESCRIPTION
CS-1	Cylinder Snapper Tool Double End Euro & Oval

## SOUBER TOOLS

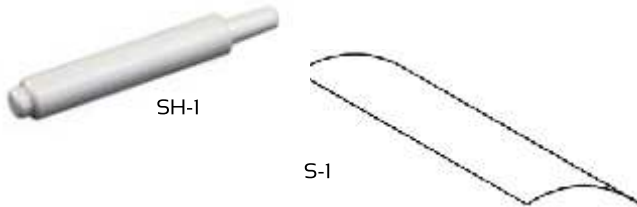

CODE	DESCRIPTION
S-1	Stainless Steel Shims Pack of 25
SH-1	Shim Holder Holds curved shims without slipping

## SOUBER TOOLS



CODE	DESCRIPTION
TIB-1	Pick - Ford Tibbe Locks - Clockwise
TIB-2	Pick - Ford Tibbe Locks - Anticlockwise

## SOUBER TOOLS



Simply pre-set the nose - insert the blade and press the button  
Supplied complete with operating instructions.

CODE	DESCRIPTION
PS2	Plug Spinner Tool
PS2-S	Plug Spinner Spring

## SOUBER TOOLS

Simple to use.  
Spreads wafers to allow key removal  
Spiral wire pulls out broken key part.



CODE	DESCRIPTION
BKES	Broken Key Extractor System 3 items
BKES-F	Forceps only
BKES-WH	Replacement Spiral Wire with Handle

## SOUBER TOOLS

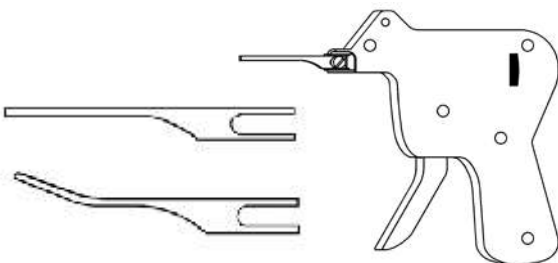

CODE	DESCRIPTION
LPG-1	Majestic Pickgun incl. 3 Blades & 1 Tension Tool
P-2	Pickgun Blade Replacement

## SOUBER TOOLS

Colour coded for quick identification  
Designed to suit both standard and deep cap locks



CODE	DESCRIPTION
HD-TT1	Tension Tool Heavy Duty Standard Red
HD-TT2	Tension Tool Heavy Duty Wide Blue

# LOCKSMITH TOOLS

## SOUBERTOOLS

The DBB Morticer, manufactured by Souber Tools, produces a perfect lock recess every time. It is a genuine 5 minute morticer which is acclaimed by locksmiths and builders alike. For anyone who regularly fits mortice locks it will prove invaluable - an accurate, speedy and professional tool that will save time and money.



- Simple and Easy to use
- Suitable for Wooden Doors
- Cutters for Aluminium Doors Available
- Quick change cutter feature
- Cuts Lock Forend as well as Lock Body
- Supplied complete with comprehensive instructions
- Complete with plastic carrying case

CODE	DESCRIPTION
DBB1	Souber Tools Morticer with 3 Cutter

## SOUBERTOOLS

- Capable of drilling out many locks
- Made of high grade tempered steel
- Does not destroy pins
- Enables decoding of key combination



CODE	DESCRIPTION
TLC1	Tubular Lock Cutter

## SOUBERTOOLS

- Krypton - Broad Spectrum Bulb
- Switchless design
- Lightweight aluminium body
- Complete with storage tube



CODE	DESCRIPTION
AL-10500	Car Opening Light 2AA Cell Hardbody

## HPC GRAPHITE GUN

- Fine dry lubricant - sprays in any direction.
- Refillable Rubber Holder
- Spill-Proof
- Clog-Proof
- Leak-Proof



CODE	DESCRIPTION
HGG	Graphite Powder LockLubricant



"JUST-A-PUFF" is a special dry lubricant developed for cylinders and padlocks.

Does not attract dust and dirt like traditional lubricants that would clog up the sensitive pins and springs inside.



CODE	DESCRIPTION
DY21402	Graphite Powder LockLubricant

# LOCKSMITH TOOLS

GOSO



GOP-C47

GOB-????

**CODE DESCRIPTION**

GOP-C47 Tension Wrench with Light

GOSO

GOP-B08



**CODE DESCRIPTION**

GOP-B08 Tension set of 2

GOSO

GOB-B03



**CODE DESCRIPTION**

GOP-B03 Tibbe Pick disc

GOSO

GOB-B11



**CODE DESCRIPTION**

GOP-B11 Tibbe Pick Drums

GOSO

GOP-B17



GOP-B01

GOSO pick Audi/VW/Porche/Seat

**CODE DESCRIPTION**

GOP-B17 Tension Wrench D/sided

GOP-B01 GOSO pick Audi/VW/Porche/Seat

GOSO

GOP-C31



**CODE DESCRIPTION**

GOP-C31 GOSO picks Tricircle D/link Boston

GOSO

GOP-C40



**CODE DESCRIPTION**

GOP-C40 GOSO Tubular Pick 9.6 X 7.5

GOSO

GOB-B18

GOB-B04



**CODE DESCRIPTION**

GOP-B18 GOSO Pick Honda

GOP-B04 GOSO Pick BMW/Peugeot



# LOCKSMITH TOOLS

## FACE CAP REMOVAL TOOL



Curved end of Jaw follows curved outside surface of the face cap to minimize the likelihood of damaging the cap thus allowing re-use

CODE	DESCRIPTION
EAG	Multi-Purpose Face Cap Removal Tool

## KLOM



CODE	DESCRIPTION
KL-BMW.P	High Quality BMW Pick

## SOUBERT TOOLS

Mercedes Lock Cutter Kits

Each kit comes with clear Instruction Booklet



CODE	DESCRIPTION
MCA	Tool A This tool is only for use on Merc Ignition locks which have a single marginal hole in the face cap of the ignition lock
MCB	Tool B This tool is only for use on Merc Ignition locks which have two marginal holes in the face cap
MCC	Tool C This tool is only used on Merc Ignition locks of the C & E Class from 1994 onwards. These locks are to the right of the steering column and have NO marginal hole/s in the face cap.

## TUBULAR PICK

WITH FREE DEPTH DECODER



CODE	DESCRIPTION
GL-205	Tubular pick in pouch for ace tubular

## KLOM



CODE	DESCRIPTION
KL-307	Master Pickset System 32 piece in 1

## KLOM

Complete set of picks and extractors

Spin Tool

Scissor Jigglers



CODE	DESCRIPTION
KL-MAGIC	Klom High Quality Tool Kit in Case

## SOUBERT TOOLS

Circlip Removal Tool - this tool enables the quick and easy removal of circlips on euro profile and rim cylinders.

- blade made from hardened steel
- works on spring steel, brass and mild steel circlips
- supplied complete with handle and spare blades
- instructions included



CODE	DESCRIPTION
CRT2	Circlip removal tool

# LOCKSMITH TOOLS

## SAFE LOCK PICKSET

Easily Open 7 Lever Assa Abloy  
N8 and N94 Safelocks



CODE	DESCRIPTION
LF-SAFE	7 Lever Safe Lock Pickset



Re-Keying Kit and Spares for N8 - N94 Safelocks  
N302 Gatelock Levers  
Starlock Washer for T & L Handles  
60 Series Wafers (camlocks)  
R02 Series Wafers (garage locks)  
Curtains for NI06 - NI08 Safe Locks  
64 Series Wafers  
60 - 64 R02 Guide Space and Depth Keys  
60 - R02 - R06 codes



CODE	DESCRIPTION
LX1001	Wafer Kit Assa Abloy Complete

## SOUBER TOOLS

A boxed pinning kit with 85 sizes of pins

- 144 of each size of pin
- Pins in 5 thou (0.005") increments
- Compartments for tweezers, followers & springs
- Steel carrying case with moulded plastic insert tray
- Numbered compartments
- Spare pins also sold separately (order size & type)



CODE	DESCRIPTION
OEM19	Pinning Kit Souber Tools Universal

## SOUBER TOOLS

Pinning Shoes - A range of pinning shoes for re-pinning euro-profile & oval cylinders.

- plated finnish prevents rusting
- illustrated step-by-step instructions
- Heavy duty design to prevent breakage in use



CODE	DESCRIPTION
PS/E/L	Pinning Shoes Euro Profile 6 Pin
PS/E/S	Pinning Shoes Euro Profile 5 Pin
PS/O/L	Pinning Shoes Oval Cylinder 6 Pin
PS/O/L	Pinning Shoes Oval Cylinder 5 Pin

## SOUBER TOOLS

Circlip Pliers - specially designed for fitting Brass and Mild Steel circlips to euro profile and rim cylinders

- simple and easy to use
- made from hardened tool steel
- comfortable easy grip handles

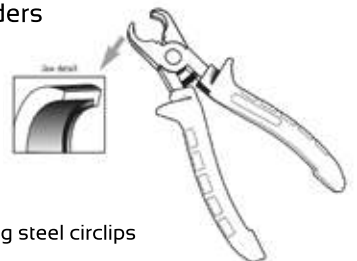

NB unsuitable for use with spring steel circlips

CODE	DESCRIPTION
CPI	Circlip Pliers

# LOCKSMITH TOOLS

## LISHI



LIP-HU64  
PICK

CODE	DESCRIPTION
LIP-HON60	Honda Square Old
LIP-HON66	Honda
LIP-HU100	Opel 2 Track
LIP-HU101	Ford Landrover
LIP-HU39	Merc 4 Track
LIP-HU43	Opel 2 Track
LIP-HU56	Volvo -2 Track
LIP-HU58	BMW 4 Track
LIP-HU64	Merc 2 Track
LIP-HU66-1	Audi/VW
LIP-HU66-2	Audi/VW
LIP-HU83	Peugeot
LIP-HU92	BMW Ice
LIP-HY3	Hyundai 3
LIP-HYUND	Hyundai
LIP-NE66	Volvo Ice
LIP-SAAB2	SAAB Ice
LIP-TOY40	Toyota Lexus Cruiser
LIP-TOY48	Toyota Lexus Cruiser
LIP-VA2T	Citroen
LIP-YM30	SAAB 2 Track



LIR-HU64  
READER

CODE	DESCRIPTION
LIR-HON60	Honda Square
LIR-HON66	Honda
LIR-HU100	Opel 2 Track
LIR-HU101	Ford
LIR-HU39	Merc 4 Track
LIR-HU43	Opel 2 Track
LIR-HU56	Volvo
LIR-HU58	BMW 4 Track
LIR-HU64	Merc 2 Track
LIR-HU66-1	VW 1
LIR-HU66-2	VW 2
LIR-HU83	Peugeot
LIR-HU92	BMW Ice
LIR-HU92-2	BMW Ice #2
LIR-KIA-CHR	Kia CHR
LIR-KIA-ENT	Kia
LIR-NE66	Volvo Ice
LIR-SAAB-2	SAAB
LIR-TOY40	Toyota
LIR-TOY48	Toyota
LIR-VA2T	Citroen/Peugeot
LIR-YM30	SAAB

## LISHI



LIT-CUT

CODE	DESCRIPTION
LIT-CUT	Key Cutter All Types.

## NICHOLSON FILES - WARDING BASTARD



CODE	DESCRIPTION
N-16507	Nicholson File Warding Bastard 4 inch
N-16663	Nicholson File Warding Bastard 6 inch
N-16761	Nicholson File Warding Bastard 8 inch

## FILE HANDLES



RFH05

RFH04

CODE	DESCRIPTION
RFH04	Tilney File Handle 4 inch
RFH05	Tilney File Handle 5 inch

## NICHOLSON FILES - WARDING 2ND CUT



CODE	DESCRIPTION
N-16540	Nicholson File 2nd Cut 4 inch
N-16696	Nicholson File 2nd Cut 6 inch
N-16794	Nicholson File 2nd Cut 8 inch

# LOCKSMITH TOOLS

DINO



**CODE**

**DESCRIPTION**

RGN-225

Pick Gun Dino

DINO

Pick Tool Set  
Specially designed  
for opening 2  
track Keys eg Audi,  
Porche, VW



**CODE**

**DESCRIPTION**

RGN-209

Pick Tool Set - complete with spinner

DINO

3 in 1 : Look - Read - Pick

Designed for auto Lock Opening  
on all wafer locks.

View into and magnify and  
illuminate keyway.

Intense White LED Light



**CODE**

**DESCRIPTION**

RGN-211

3 in 1 Navigator Scope

DINO



Helps examine cylinder keyways clearly

Aluminium Alloy - Waterproof

Super intense LED white light

**CODE**

**DESCRIPTION**

RGN-219

Locksmith Scope Led

DINO



Pickset contains 9 most popular pick blades inside the  
handle of pen.

The clip acts as a tension wrench.

Made of high quality materials and made to look like a  
quality pen

**CODE**

**DESCRIPTION**

RGN-212

Pen Pickset 9 pick blades

DINO



**CODE**

**DESCRIPTION**

RGN-213

Pickset - visible tubular set (training use)

TELESCOPIC POCKET MAGNET



Pocket size pen magnet that extends to 64cm

**CODE**

**DESCRIPTION**

TC169-3

Telescopic Pocket Magnet

KLOM



**CODE**

**DESCRIPTION**

KL-BMW.P

BMW Pick High Quality

# UTILITY BLANKS

## SAFE

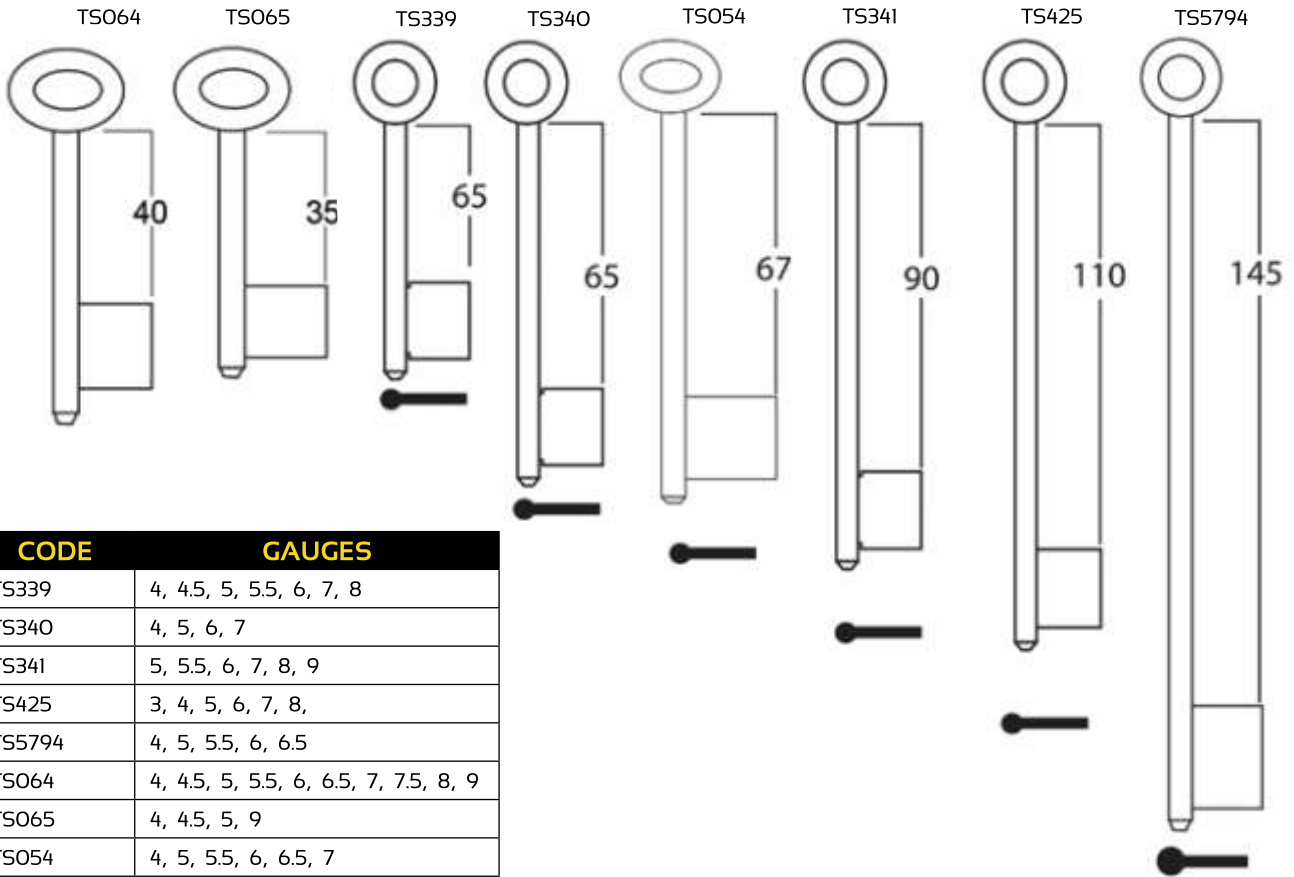

CODE	GAUGES
TS339	4, 4.5, 5, 5.5, 6, 7, 8
TS340	4, 5, 6, 7
TS341	5, 5.5, 6, 7, 8, 9
TS425	3, 4, 5, 6, 7, 8,
TS5794	4, 5, 5.5, 6, 6.5
TS064	4, 4.5, 5, 5.5, 6, 6.5, 7, 7.5, 8, 9
TS065	4, 4.5, 5, 9
TS054	4, 5, 5.5, 6, 6.5, 7

## RIM

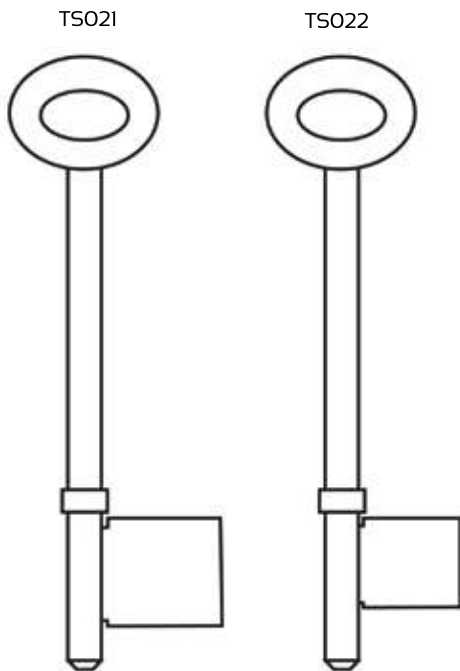

CODE	GAUGES
TS021	1, 2, 2.5, 3, 3.5, 4, 4.5, 5, 5.5, 6, 7
TS022	5, 5.5, 7

## PIN & PIPE GAUGE

For the identification of the correct gauge of Mortice Pin and Pipe key blanks. Includes half sizes for 4.5 and 5.5 only.

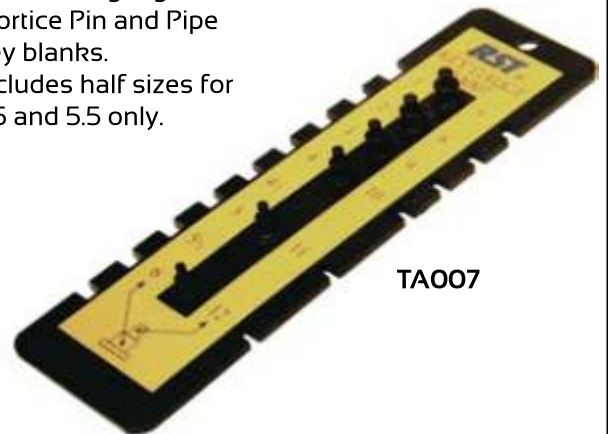

GAUGE	mm	GAUGE	mm
1	7.60	5	5.38
2	7.00	5.5	5.13
2.5	6.71	6	4.88
3	6.40	6.6	4.67
3.5	6.15	7	4.47
4	5.89	8	7.60
4.5	5.64	9	7.00

# UTILITY BLANKS

## PIPE BLANKS

TS047

TS048

TS072

TS073

TS075

TS076

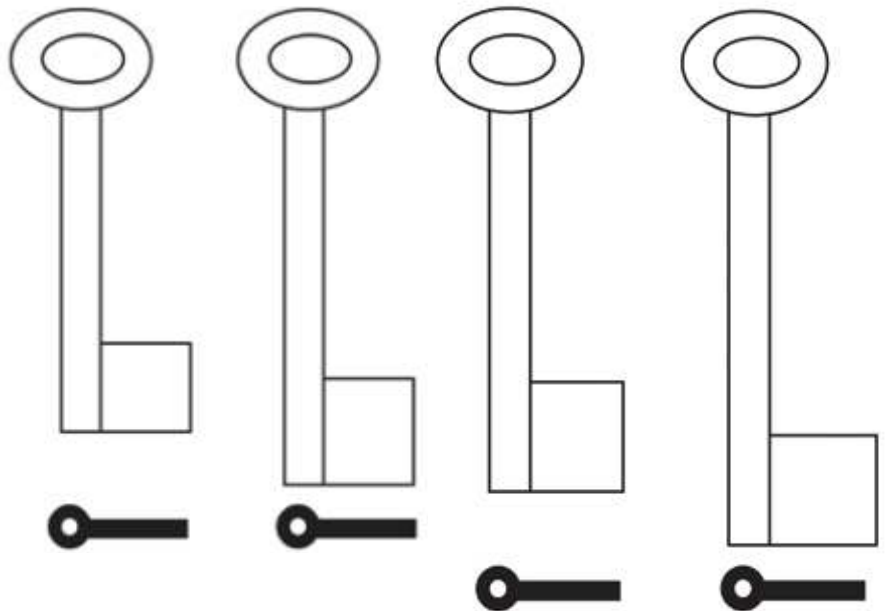
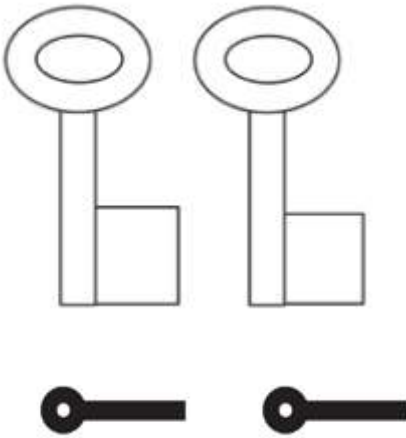

CODE	GAUGES
TS047	6, 7, 8,
TS048	7, 9, 10
TS072	8, 9, 10, 11
TS073	8, 9, 10, 11,
TS075	8, 9, 10, 11,
TS076	5, 9,

## MORTICE

TS036

TS037

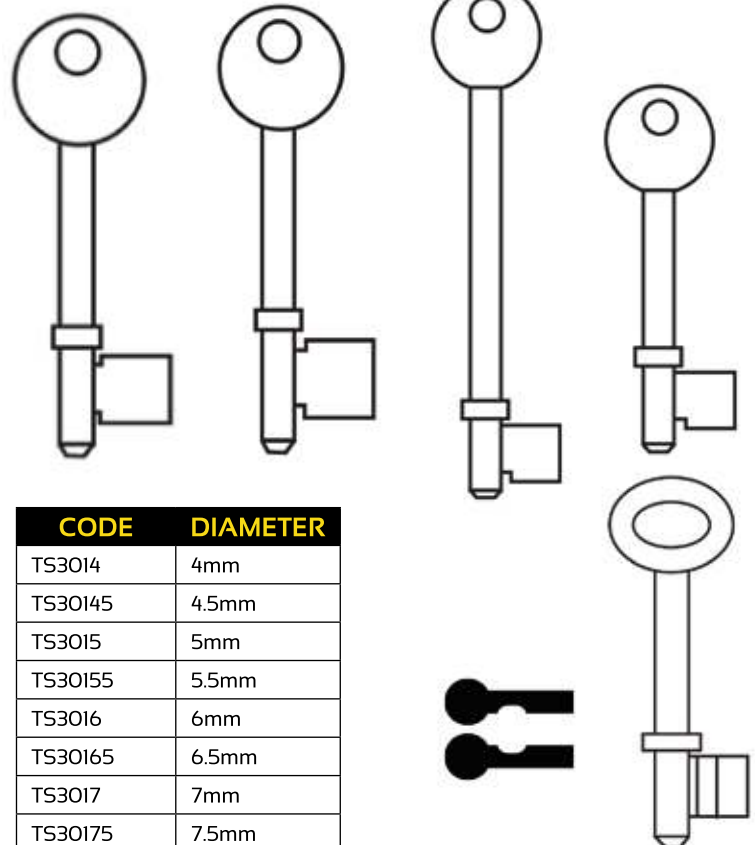
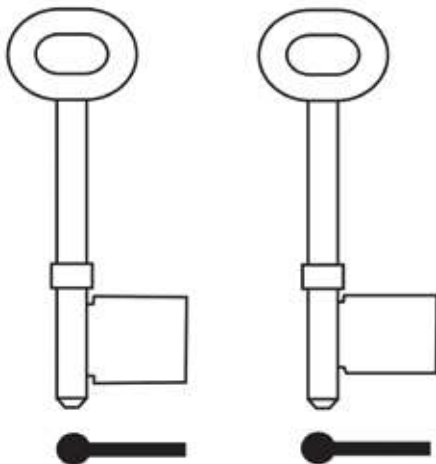

CODE	GAUGES
TS036	3, 3.5, 4, 4.5, 5, 5.5, 6, 6.5, 7, 8
TS037	3, 3.5, 4, 4.5, 5, 5.5, 6, 6.5, 7, 7.5, 8
TS039	3.5, 5, 5.5, 6, 6.5, 7, 7.5
TS177B	5 Brass Key
TS179B	4.5 Brass Key
TS181	3 Lever Blank
TS189LH	4.5 Left Hand
TS189RH	4.5 Right Hand
TS144	5 4 Lever Blank
TS139	5.5 Yale 3 Lever

CODE	DIAMETER
TS3014	4mm
TS30145	4.5mm
TS3015	5mm
TS30155	5.5mm
TS3016	6mm
TS30165	6.5mm
TS3017	7mm
TS30175	7.5mm

# UTILITY BLANKS

## FLAT STEEL

TS082



TS084



TS085



TS093



TS101



TS110



CODE	DESCRIPTION
TS082	Tilney 82
TS084	Tilney 84
TS085	Tilney 85
TS093	Tilney 93
TS101	Tilney
TS110	Tilney
TS111	Tilney

## CHUBB

TS227



TS196B

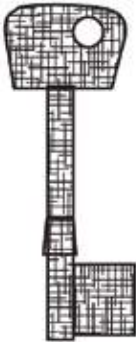

TS179B

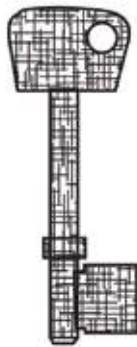

TS177B



TS120

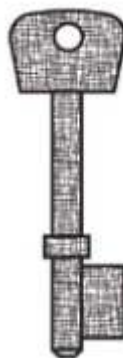

TS339

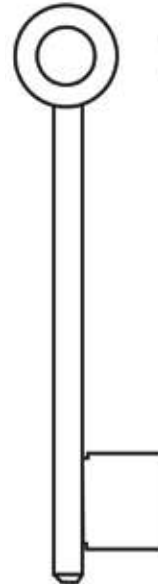

TS340

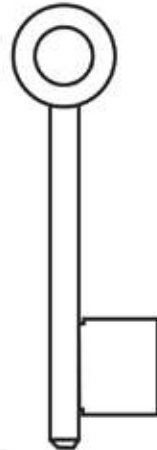

TS341

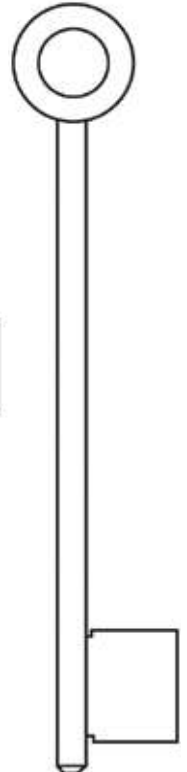

CODE	GAUGES
TS120B	5G
TS132	6.5G
TS177B <	5G
TS179B<	4.5G
TS227<	7G
TS196B<	4.5G
TS339	4, 4.5, 5, 5.5, 6, 7, 8
TS340	4, 5, 6, 7,
TS341<	4, 5, 5.5, 6, 7, 8, 9

# KEYBLANKS

**UNION**  
ASSA ABLOY

LT1351 L/H ORIGINAL 5G  
LT1352 L/H THICKER 4.5G  
LT1354 R/H OPPOSITE 5G

UT1352/R - A 4G  
UT1352/R - B 4G  
UT1352/R - C 4G  
UT1352/R - D 4G

**ELZETT**

5.5G  
JMA ELZ-1G  
KEYLINE 1ELZ1

5G  
JMA ELZ-7G  
KEYLINE 1ELZ2

**GLADIATOR**

GDBB  
Gladiator Old  
Groove Only

GDBN  
Gladiator New  
Groove & Ridge

**DORMA**

56000388  
DORMA 5L

56000381  
DORMA LH

56000380  
DORMA RH

**POB**

POB  
A = 6.5G / 4.6mm

POB7-ATP  
A = 7G / 4.33mm

**BBL**

BBY01  
BBL dimple  
keyblank for  
Union 1022G

BB700  
Blank for BBL700

BB302  
Blank for  
BBLN302

BB201  
Blank for BBLN201

**UNION**  
ASSA ABLOY

G-N201

LT13033



# CUTTERS - MORTICE



REF	MACHINE	EQUIV	TYPE	D	S	D	L	TEETH	MA
26.101.H10	JMA Ecco Bit	FP8	Side	63.00	1.40	16.00		80	HS
27.515.C00	Jarey Mk2 750sg-CA	TMC7513-CA	Side	70.00	1.30	12.70		72	6A/42e
TOC3JK	Jarey Mk2	53020H30	Warding	32.00	1.30	11.40		60	HS
TMC850	RST Mancuna	TMC850/0085W	Warding	32.00	1.40	12.70	14.30	75	6A/35
40.003.H30	RST Mancuna	TMC850/0085W	Warding	32.00	1.40	12.70	14.30	75	6A/35
40.005.H30	Silca Lancer	D7031144ZB	Warding	25.00	1.25	12.00	23.00	40	6A/35
52.524.H10	Silca Lancer Plus	D711119ZB	Warding	25.00	1.25	10.10		40	6A/35
40.002.H30	Orion Mizar Warding	D410015ZZ	Warding	32.10	1.35	18.00	16.00	60	6A/42
51.503.C00	Keyline 993	PL1.25	Slit	100.00	1.25	22.00		100	6A/35e
51.503.C00.Z130	Keyline 993	PL1.25	Slit	100.00	1.25	22.00		130	Carbide
56.570.C00	Silca Form X No.5	D705633ZB	Code Ford Ava	60.40	1.80	9.53		68	Carbide
28.513.C00	Orion Mizar		Mortice	80.00	1.50	22.00		100	Carbide
28.002.H10	Silca Lancer SG6	D700204ZB	Side	80.00	1.30	22.00		100	HS
28.003.H10	Silca Lancer SG2	D7017	Side	80.00	1.50	22.00		100	6A/42
28.512.C00	Silca Lancer SGIW	44ZB	Side	80.00	1.30	22.00		100	6A/42e
56.011.H10	Misc Machine	CU15 KD15	Slot	63.00	1.40	16.00		80	HS
56.025.H10	Misc Machine	CU15 KD15	Slot	63.00	1.50	16.00		80	6A/42
57.210.H10	Misc Machine	F57012	Slot	70.00	1.20	22.00		80	6A/42
RIC01862B	Keyline 206		Warding	25.00	1.25	5.00		40	6A/42
RIC01864B	Keyline 206		Side and Face	80.00	1.40	22.00		100	6A
RIC02865B	Keyline 993		Electronic Mortice	100.00	1.25	22.00		130	6A/bide

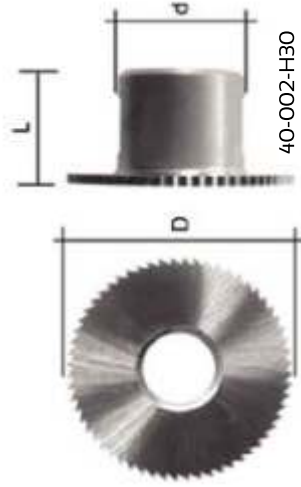

40-002-H30



52-524-H10



40-005-H30

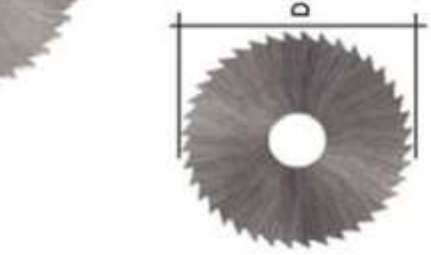

56-011.H10



# CUTTERS - LATCH



77.035.H20

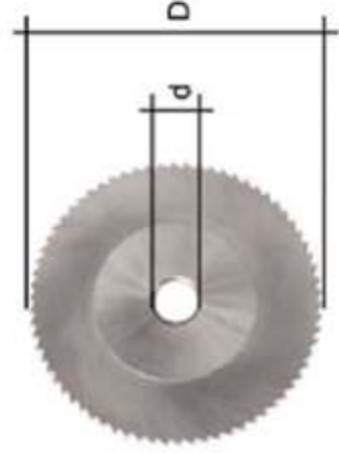

REF	MACHINE	EQUIV	TYPE	D	S	d	β	TEETH	MA
14.301.C00	Erebi Epsilon	FP2W	Latch Automatic	40.00	6.00	10.00	35/22.5	40	Carbide
16.019.H30	JMA/Erebi Ecco	ECCO_009	Latch Manual	63.00	5.00	16.00	84	80	HS
16.021.H30	SIL	D702844ZB	Manual Code	60.40	7.20	9.53	100	80	HS
16.022.H30	5A FORM X No.1	D702845ZB	Manual Code	60.40	7.60	9.53	100	80	HS/35
16.023.H30	5A FORM X No.2	D702846ZB	Manual Code	60.40	7.20	9.53	100	80	HS/35
56.570.C00	5A 5000X/IN035	D705633ZB	Manual Code Ford Ava	60.40	1.80	9.53		68	Carbide
56.575.C00	Silca Form X No. 6	D706128ZB	Manual Code Ford Tibbe	64.60	2.40	9.53		70	Carbide
16.033.H30	Silca delta	D911868ZR	Latch Manual	60.40	5.25	9.53	84	70	HS
16.504.CO	Silca Unocode UOIW	D705933ZB	Electronic Code Machine	60.40	5.25	9.53	80	70	Carbide
16.504.C00.N	Silca Unocode	D705933ZB	Electronic Code Machine	60.40	5.25	9.53	80	70	Carbide+Coated
18.002.H30	Erebi latch	CU11/26MC	Latch Manual	80.00	5.00	16.00	80	100	HS
18.004.H30	Silca Rekord		Latch manual	80.00	5.00	16.00	84	110	HS/35
18.050.H30	Silca Rekord 2000 POI	D700875ZB	Latch Manual	80.00	5.00	16.00	84	110	HS/35
18.501.C00	Silca Bravo POIW	D704861ZB	Copy Latch /Car Key	80.00	5.00	16.00	84	110	Carbide
FP24	JMA Titan 4	FP24	Latch Manual	80.00	5.00	16.00	42	100	HS
75.003.A00	Iico Machine 23RF	23RF	Latch Manual	57.15	6.35	12.70	45	168	W2
7.051.H20J	U5101	U5101	Latch Manual	60.45	7.30	12.70		60	HS
77.035.H20	Iico Machine 19MC	19MC	Latch Manual	73.02	7.14	12.70	60	110	S M2 Coated
77.052.H30	Gladaid	GL333A	Latch Manual	70.00	6.00	20.00	40	80	HS
77.052.H30J	Gladaid	GL333A	Latch Manual	70.00	6.00	20.00	40	60	HS/35
RIC01720B	Keyline Karat		Latch	80.00	5.00	16.00			S M35 Coated
CW-105	HPC Blitz						105		
CW-23MC	HPC Smartie								
RIC05826B	Keyline Dezmo		Electronic Latch Machine	80.00	5.00	16.00	80		Carbide



16.033.H30



18.050.H30



7.051.H20

# CUTTERS - MILL/DRILL

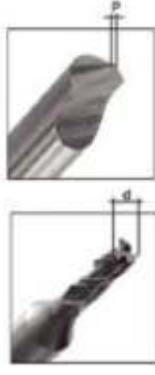

30.034.H30

REF	MACHINE	EQUIV	TYPE	D	L	P	β	TEETH	MA
30.020.H30	JMA Dakar F12A	D701091ZB	Drilling /Mul T Lok	6.00	48.00	0.40	100	2	HS
JMA-P12A	JMA Dakar	P12A	Tacer-Drilling M.I Lock Inner	6.00	45.00	1.60	100		BS
JMA-P12B	JMA Dakar	P12B	Tacer-Drilling M.I Lock Outer	6.00	45.00	2.10	100-90		BS/35
30.034.H30	Silca Club /Matrix F4	D701077ZB	Drilling	6.00	48.00	0.40	90	1	BS/35
30.505.C00	Silca Qcode T	D709242ZB	Drilling	6.00	40.00	0.70	90	1	Garbide
32.021.H30	Silca Club Doge Matrix F12B	D701093ZB	Drill M T Lok Outer	6.00	48.00	1.80	90	2	HS
32.029.C00	Silac Club Doge Matrix FI-CA	DZCL1071W	Drill	6.00	48.00	0.80	90	2	Garbide
32.101.H30	JMA Dakar FI	D701071ZB	Drill	6.00	48.00	0.80	90	2	HS
32.139.C00	Silca Qcode T	HI39	Drill M T Lok Outer	6.00	40.00	0.90	60/50	2	BS
32.503.C00	Silca Qcode T	D709240ZB	Drill	6.00	40.00	0.80	90	2	Garbide
32.504.C00	Silca Qcode T	D709241ZB	Drill	6.00	40.00	1.20	90	2	Carbide
32.505.C00	Silca Qcode T	D709242ZB	Drill	6.00	40.00	0.70	90	2	Carbide
32.510.C00	Silca Qcode T	D70924	Drill	6.00	40.00	0.60	100	2	Carbide
32.511.C00	Silca Qcode T	D709248ZB	Drill	6.00	40.00	2.75	96	2	Carbide
35.001.H30	JMA Multi Machines F12B	F12B	Drill set 4 Mul T Lok						HS
35.101.H30	JMA Multi Machines F1	F1	Drill	6.00	45.00	0.80	90/80	2	BS/35
35.124.H30	JMA Multi Machine F12B	F12B	Drill Mul T Lok Inner	6	45	2.1	100/90	2	BS/35
36.101.H30	JMA Multi Machines P1	P1	Tacer-Drill	6.00	45.00	0.80	90	0	BS/35
60.141.C00	Silca Qcode U102	D908994ZR	Decoder Drill	6.00	48.00	0.20	30		Garbide
RICO5044B	Keyline 992	V001	Electronic Drilling		90.00				
RICO5050B	Keyline 992		Electronic Engraving						
RICO5264B	Keyline 992	V007	Electronic Drilling		100.00				

REF	MACHINE	EQUIV	TYPE	D	d	L	I	TEETH	MA
33.013.C00	Silca Club Matrix F22-CA	DZCL1087W	Mill	6.00	2.50	42.00	6.00	3	Carbide
33.013.H10	Silca Club Matrix F22	D705488ZB	Mill	6.00	2.50	42.00	6.00	3	HS
33.014.C00	Silca Qcode T	D709238ZB	Mill	6.00	2.50	40.00	6.00	3	Garbide
33.015.C00	Silca Qcode T	D711604ZB	Mill	6.00	3.00	40.00	6.00	3	Carbide
33.016.C00	Silca Qcode T	D709482ZB	Mill	6.00	2.00	40.00	6.00	3	Carbide
33.019.H10	JMA Dakar F11	D701089ZB	Mill	6.00	2.50	48.00	7.00	3	HS
33.022.H10	Silca Doge Matrix Club F30	D701160ZB	Mill	6.00	3.00	48.00	6.00	3	BS/42
33.421.H10	Silca Doge Matrix Club F44	D709148ZB	Mill	6.00	2.00	40.00	6.00	3	BS/42
35.111.H30	JMA Dakar F11	F11	Mill	6.00	2.50	45.00		2	BS/42
35.111.C00	JMA Dakar F11W	F11W	Mill	6.00	2.5	45		2	Garbide
36.111.H30	JMA Multi Machines P11	P11	Tacer-Drill	6.00	2.50	45.00			HS
60.111.H30	Silca Club Doge T	D401088RA	Tacer-Mill	6.00	2.50	48.00			BS/42
60.122.H30	Silca Club Doge T	D405487RA	Tacer-Mill	6.00	2.50	42.00			BS/35
60.140.C00	Silca Qcode U101	D90907	Decoder Mill	6.00	1.20	48.00			Garbide
RICO5048B	Keyline 992 V003	V003	Electronic Mill		2.50				
RICO5304B	Keyline 994	WC011A	Electronic Milling		2.50				
RICO3840B	Keyline 994 max 111	6ZR	Electronic Mill Honda		3.00				

# KEY CUTTING MACHINES

**KZ KEYLINE**

**BI-992**

## 3-AXIS COMPUTERIZED MILLING MACHINE



The **VERSA** is the fastest 3-Axis Milling Machine available.

Automatic callibration with key counter.

Stand-alone with database and codes - no computer required.

Cuts keys to code or copy sample key.

Engraving can be done on the head of the key

Cutter specific or general cutter can be used for drilling/dimple keys.

Complete with 4 jaws - Optional jaws available.

**KZ KEYLINE**

**BI-996**

## COMPUTERIZED CAR & LATCH MACHINE



The **DEZMO** is the fastest latch and car code electronic machine available.

Has a high workload rating

High Speed High Resolution Camera on machine to accurately copy and decode keys to original specification or as per sample.

4-sided jaw with quick release and turn lever - no more swarf in your fingers.

Auto-feeder option.

Driven by Instacode onboard data base - communicates with Instacode

1 GIG memory - largest stand alone data base in the world.

Carbide Wierda Cutter for high speed cutting and longer life of cutter

# KEY CUTTING MACHINES

**KZ KEYLINE**

**BI-993**

## ELECTRONIC MORTICE MACHINE



The Power Lynx is an Electronic Mortice Machine - when perfection and accuracy are demanded

Has a high resolution camera and a database of keys and codes so keys can be copied or cut by code.

Stand-alone machine - no other computer is necessary

Standard with mortice and double bitted jaw.

Keys cut without removing or rotating keys in the jaw.

Communicates with Instacode Base Program - no interface required.

Machine can cut non conductive key material eg. Zamak

Optional Jaws available: Ford Tibbe, Abloy, Abus, Chubb RKS and Kromer

**KZ KEYLINE**

**BI-994**

## 2-AXIS COMPUTERIZED MILLING MACHINE



Best 2-Axis Milling Machine available in it's class.

Supplied complete with 4 jaws to clamp all auto-lazer/milled keys.

Full database of all keys cut to code as well as de-code and copy.

Keys can be cut by bitting only when stripping lock.

This stand alone machine includes software and all cutting data.

Can retain customer details as well as keys cut.

Communicates with Instacode Base program - no interface required.

Often purchased together with the Manual Milling/ Drilling Machine

# KEY CUTTING MACHINES

**KZ KEYLINE**

**BI-106**



One of the best Latch Machines available -It is incredibly accurate, comfortable and easy to use.  
New Easy Jaw Rotate Mechanism - No more swarf in your fingers - grooves milled away at the base of jaw to allow the swarf to fall away from the jaw.  
4-Sided Jaw.  
Replaceable Tracer Point - quick and easy to replace.  
Key Gauge Protection - Carriage cannot move forward until the key gauge is in the down position.  
Machine automatically starts running when carriage is moved forward.  
Machine can be ordered without the light fitting.

**KZ KEYLINE**

**BI-206**



This is the heaviest Mortice Machine in its class - with linear guides as well as dampers to allow for extremely accurate key cutting.

Cuts Mortice keys with sideways, bullet wards, double bitted keys and flat steel keys.

Key Turret can be moved from left to right allowing you to cut Bullet and Sward Keys without removing the key from the jaw.

Fixed position locator on Cutter Turret to accurately align keys with the centre axis of the cutter.

Cutter Guard on main cutter as well as the warding cutter.

**KZ KEYLINE**

**BI-FOCUS**



Machine for cutting Ford type keys by code.

It allows duplication of a coded key on both sides without having to turn the key, thanks to a special clamp with a 360° selector device to set the cutting angle.

Machine produced to CE standards.

**JMA**



Dakar Express - Milling and Drilling Machine.  
Excellent value European Milling machine.  
Extremely accurate with keyless chucks quick release system.  
LED quick calibration indicators.  
Spring loaded tracer point for dimple type keys.  
Damper springs on jaw bed.  
Carriage and head can be locked in any position.  
Complete with Mul-T Lock , milling, dimple cutters and guides.  
This machine is often purchased together with BI-994.

# KEY CUTTING MACHINES

**JMA**  
**TITAN**



Semi-Automatic duplicating  
flat / latch keys for cylinders  
and automobile locks

**JMA**  
**MULTIMARK**



**MULTIMARK ENGRAVING MACHINE**  
The Multimark machine is useful for personalizing keys,  
cylinders or other metallic surfaces with texts, images  
and logos as desired.

**GLadaid**  
**GL-303**



Best entry level Milling/Drilling machine  
Turret can be locked at any height  
Micrometer adjustments on tracer  
Springloaded tracer to locate and hold sample key  
Tracer can be locked when used for milling  
Synchronised tilting jaws 0 - 45°  
Tibbe and Tubular attachments available  
Complete with full range of cutters - largest range  
of cutters out of the box

**GLadaid**  
**GL-888A**



Dual Keycutting Machine

Multi-functional key duplicator equipped with 2  
different cutters (latch & mortice)

Latch Cutter GL8811 76 x 6 x  
Mortice GL8823 70 x 1.15 x 25.4

Used only in extremely low volume applications.

Budget Price

**GLadaid**  
**GL-888C**



Dual Keycutting Machine

Multi-functional key duplicator equipped with 2  
different cutters (latch & mortice)

Latch Cutter GL8811 76 x 6 x  
Mortice GL8823 70 x 1.15 x 25.4

Used only in extremely low volume applications.

Budget Price

# KEY CUTTING MACHINES

## RST KEY MACHINES



TM-1011

Fast and Reliable Mortice Machine

Is known for its accuracy and ease of operation.

Side and Bullet Warding easily cut.

## RST KEY MACHINES

Mortice Machine for mortice, double bitted keys and flat steel keys

Side and Bullet Warding

X and Y axis controlled with 1 lever

Radius cutting facility on key

Excellent Value for money machine

TM1019



## RST KEY MACHINES



TM1014

Ford Tibbe Machine

Keys cut to code

Extremely accurate

Does not copy from a worn sample but to original specification



## 102X

Latch and Car keys Duplicated

Reliable and Accurate

Sintered Metal Jaw

Entry level Budget Key Machine





# KEY CUTTING MACHINES

HPC



**Original Blitz 1200CMB240V**

The Original Code Machine complete with 150 Cards and 2 Cutters - Best selling code machine in the world  
Easy to use and extremely accurate machine

**OPTIONAL**



**TIBBE-CMB**

With the Tibbe Key Adapter kit you can cut both 6-space and 8-space Tibbe Keys - these keys are used by some Ford and Jaguar cars.

HPC



**CodeMax 1200MAX240V**

The CodeMax is the original computerized code machine - based on the standard Blitz machine

This standalone machine cuts most car & cylinder keys to code and can be linked to a PC with insta-code or HPC CodeSource

The cutter pivots automatically to cut high security angle keys such as Medeco

Double sided jaw

Micrometer function

Complete with 5 cutters

Easy to use LCD screen

Optional attachments available

# KEY CUTTING MACHINES

## ELLIS 103

- Tubular key duplicating machine
- 220V
- Clamp will hold keys between 7.5 and 7.8mm
- Supplied with user and setting instructions



## ELLIS 007AW

- 12V DC latch machine
- Low volume machine
- Excellent for service vehicles
- Fully portable machine



## GL-FORD

- Quality made attachment
- For originating Ford Tibbe keys
- For all makes of Milling Machines
- Complete with cutters and guides
- 360° key rotation in attachment
- Key is cut to code, ensuring a smooth operating key



# TRANSPONDER

## ADVANCED DIAGNOSTICS

### AD100Pro



AD100Pro

Transponder Key Programming

Remote Programming

Pincode Extraction, Fault Clearing

ECU Coding

Transponder Key Erasing

Updates via Web

2 Software Version loaded on machine  
- use either Standard or Beta

Purchase only selected software as required

Large LCD screen

Mechanical Keycode Extraction

## ADVANCED DIAGNOSTICS

### MVP-PRO



Extremely low initial capital outlay - the unit comes fully loaded with all software from Advanced Diagnostics including all cables and hardware.

It works like the AD100Pro except the user only pays per use with tokens purchased over the internet.

Is supplied preloaded with 10 tokens

Tester warns before deducting tokens

# TRANSPONDER

## ADVANCED DIAGNOSTICS

## AD35

### FREQUENCY TESTER

Checks whether customer remote key is working and transmitting correctly.  
Checks the antennae near the ignition barrel - provides visual & audible indication of antenna power.

On certain vehicles switching the ignition on - will indicate a frequency sent & received.

Checks & displays the exact frequency transmitted.

Prevents wasting time trying to make keys to faulty system

Supplied complete with leather pouch



## ADVANCED DIAGNOSTICS

## ADC116

### OBD TESTER

The quickest way to check that the OBD Port is supplying 12 Volts

Checks for good ground

Checks if Pin 7 on VW / VAG is connected to an aftermarket radio correctly (incorrect wiring of aftermarket radio can damage your AD100Pro / MVP-PRO)



## ADVANCED DIAGNOSTICS

## AD36

### VW/AUDI Pin Code Reader

Device that interfaces with PC for pulling System 1 Pincodes  
Immobiliser must be removed from Vehicle and once read reinstalled and the AD100PRO can then code the transponder  
Software supplied with the unit  
Manual with clear and easy to follow instructions



## ADVANCED DIAGNOSTICS

## AD37

### GM/OPEL Pin Code Reader

Device that interfaces with a PC for pulling System 1 Pincodes  
Reads Pin code by removing immobilizer from area around ignition barrel which is attached to the Aerial extremely easy to remove  
Will pul codes from locked system  
Software supplied  
Manual with easy and clear instructions



# TRANSPONDERS

## AD900PRO

### Professional Transponder Duplicating Machine

The most advanced Transponder cloning read and write machine available



- Copies all copiable transponders including Texas 4C and 4D
- Random Code Generation
- Unlocks Megamos Crypto 48
- Transponder pin Code Reading
- 50 Different EPROM programs available
- Regular updates via Web
- More details available on our Website [www.bblocks.co.za](http://www.bblocks.co.za)
- Internet connection required for certain operations
- Can be used in conjunction with Omega kit
- Can copy JMA Keyline and Silca Transponder keys

### Options

AD900PRO-FL	Fully loaded with all software and options for the locksmith that does not want to turn any business away
AD900PRO-PR	Loaded with all cloning generating software as well as pin code Calculators
AD900PRO-CL	Loaded with all Cloning Software to copy only including Texas TPX1 and TPX2

## OMEGA-F



Full Kit - Locksmith will need to read most microprocessors and eeproms

Complete with all clips, cables and adaptors

Used in conjunction with AD900Pro

Adaptor to read Nissan Nats 5 codes through connector plug on aerial

BMW EWS3 in circuit reading

Can read a wide range of vehicles

# TRANSPONDER CODES

SIL	JMA	ADV	EASTB6B	USE	TRANSPONDER	JMA NOTES	MANUF	TYPE	ID
CA1	TP05	ADV		M	TEMIC FIX CODE	ORIGINAL-FIA	PCF793IXP/SQ		
T2	TP05	ANCED		M	TEMIC FIX CODE	ORIGINAL-FIA	PCF793IXP/C		
T5	TP05			M	TEMIC FIX CODE	ORIGINAL-FIA	NOV		
T2	TP05	AKTP17		M	TEMIC FIX CODE	ORIGINAL-MAZDA / 40	ACTUP-NOV PCF793IXP/C		ID33
T5	TP05	AKTP14		M	TEMIC FIX CODE	ORIGINAL-MAZDA / 40	NOV10		
TP03	AKTP1		ETT5-20	M	MEGAMOS FIX CODE	ADV		T5 GLAS	ID13
TP05	AKTP17			M	PHILIPS FIX CODE	ORIGINAL-EMULA	PCF793IXP/SQ		
T2	TP05	AKTP14		M	PHILIPS FIX CODE	ORIGINAL-EMULA	CODEPCF793IXP/C		
T5	TP05	AKTP14		M	PHILIPS FIX CODE	ORIGINAL-EMULA	NOV		
T9	TP09	AKTP12	ET40GM1	M	PHILIPS CRYPTO CODE	ORIGINAL/GM OPEL.	PCF79	CARBON CRYP WHITE	ID40
T12	AKTP13			I	PHILIPS CRYPTO CODE	ORIGINAL/GM OPEL.	AG010	CARBON CRYP GOLD	ID40
T11	AKTP8			M	PHILIPS CRYPTO CODE	ORIGINAL/NIS	PCF79	CARBON	ID41
T10	AKTP3	ET42V		M	PHILIPS CRYPTO CODE	ORIGINAL/V	PCF7935DS	CARBON	ID42
T15	AKTP4			M	PHILIPS CRYPTO CODE	ORIGINAL/V	7355	CARBON V	ID45
TP16	AKTP26			M	PHILIPS CRYPTO CODE	ORIGINAL/PEUGEOT		CARBON	ID46
TP12	AKTP5	AG2		I	PHILIP 2 Gen. CRYPT CODE	ORIGINAL/PSA ONL		PSA/HYUND CARBON	ID46
TP08	AKTP2			I	MEGAMOS CRYPT CODE	AG2ND SERIES	806004	ADV	ID48
TP02				I	TEXAS FIX CODE	ORIGINAL	RI-TRP-R9HP-06	A EOPYTPX1	4C
TP07				I	TEXAS FIX CODE	ORIGINAL	RI-TRP-R9WIK	ANC-GLAS	
TP06				I	TEXAS FIX CODE	GENERIC	RI-TRP-B9WIK	COPYTPX2	4D60
TP19	AKTP7			M	TEXAS CRYPTO CODE	GENERIC	RI-TRP-B9WIK	COPYTPX2	4D60
TP26	AKTP19			M	TEXAS CRYPTO CODE	GENERIC	RI-TRP-B9WIK	COPYTPX2	4D61
TP28	AKTP20			M	TEXAS CRYPTO CODE	GENERIC	RI-TRP-B9WIK	COPYTPX2	4D62
TP20	AKTP15			M	TEXAS CRYPTO CODE	GENERIC	RI-TRP-B9WIK	COPYTPX2	4D63
TP21	AKTP21			M	TEXAS CRYPTO CODE	GENERIC	RI-TRP-B9WIK	COPYTPX2	4D64
TP27	AKTP22			M	TEXAS CRYPTO CODE	GENERIC	RI-TRP-B9WIK	COPYTPX2	4D65
TP05				M	PHILIPS FIX CODE	ORIG - MUL	NOV	CARB COPYTPX2	
TP17				M	TEMIC CRYPTO CODE	ORIGINAL			
T3	AKTP9			M	TEXAS CRYPTO CODE	ORIGINAL	A 3010	GLAS	
TP05	AKTP14			M	TEMIC FIXED CODE	ORIGINAL		GLAS	
T2	AKTP16			I	PHILIPS CRYPTO RENAUL	IP44 HIT		CARBON	
	AKTP23			I	PHILIPS CRYPTO MITSUBISHI	IP44 HIT		CARBON	
T4	AKTP24			M	TEXAS FIXED CODE	OCK		CARBON	ID44
	AKTP25			M	TEXAS FIXED CODE	OCK		CARBON	
	AKTP27			I	EWS3 CHIP USE WITH AD91	AG2.CRYPTO		CARBON	
	AKTP28			I	ID41 USE WITH AD90/AD95			CARBON	ID41
	AKTP29			I	ID44 USE WITH AD90/AD95			CARBON	ID44
	AKTP30			I	ID45 USE WITH AD90/AD95			CARBON	ID45
TPX1				I	AD900PRO CHIP COPY ID41/42/44/45/MERC-C-E-G/ID33			CARBON	
TPX2				M	TEXAS GLAS	COPY TEXAS 4C		GLAS	
				I	TEXAS GLAS	COPY TEXAS 4D		GLAS	
		ET46CITI		I	T	ET46CIT-PICAS		S	ID46
		ET46MITI		I		ET46MIT-COL		S	ID46
		ET46P		I		ET46PEUG307			ID46
		ET46RENI		I	S	ET46RENAUL			ID46
		ET46V		I	S	ET46TOUAREG			ID46
		ET44GEN		I		ET44-GENERAL			ID44
		ET45PSAI		I		ET45PEUGEOT			ID45
		ET45CIT3		I		ET45PSAI			
				I		ET45PSAI			

# TRANSPONDER

**JMA** 

## TRS-5000 + TPX CLONER

THE SIMPLEST AND MOST ADVANCED WAY TO CLONE KEYS WITH  
TPX1 & TPX2 TRANSPONDERS FROM JMA



TRS5000



TPX CLONER

The solution for cloning Texas Fixed and Crypto Transponders - especially designed for cloning transponders in the new TPX1 and TPX2 transponders developed by JMA.

The TPX Cloner will always operate connected to the TRS-5000 machine via the RS-232 serial port and no internet connection is required.

Clones most cars including Ford, Opel (incl. Crypto Unlocked) Toyota, Nissan, Mitsubishi, Volkswagen (up till 2002) Peugeot, Mercedes Sprinter and numerous other vehicles.

Will also unlock TPO8/ID48 Megamos.

Can also be connected to the AD900PRO, making the cloning of TPX transponders stand alone

**BEST SELLING CLONER IN SOUTH AFRICA**

## WH SOFTWARE

### THE TOTAL LOCKSMITH MANAGEMENT TOOL



InstaCode is considered the leading Key Data Software throughout the world. With over 3 billion key codes, and new codes added daily, InstaCode is a vital tool for any professional locksmith.

Compared to code books or any other code package, Instacode is a quick, easy to use program.

A graphical layout displaying space & depth information, flat widths, angles, card number and other relevant key cutting information makes InstaCode easier to use than many alternatives.

#### WH-BASE

##### **Instacode Base Program**

- Print cards for HPC machine
- Print out entire code series
- Regular updates via internet
- Optional add-on packages
- Finds missing cuts if wafers are not in lock and will provide a cutting tree
- Communicates with most electronic machines eg. Silca Unocode, Quattrocode, Triax (with add on module) HPC Blue Shark Codemax, JMA Procode, Keyline 994, Versa & 993 and others

#### WH-AUTO

##### **Instacode Automotive Add-on Module**

- Optional add-on to Instacode Base Program
- Provides detailed information on ASP replacement locks
- Provides detailed opening information and diagrams of ASP locks
- Transponder information as well as position of diagnostic plugs etc.

#### WH-MIKEY

##### **Instacode Masterkey Add-on Module**

- Optional add on to Instacode Base Program, allowing locksmiths to design simple masterkeying projects

#### WH-POCK

##### **Instacode Pocket Software - Add-on or Standalone**

- Optional add or standalone package, which can be loaded on a PDA or mobile phone which runs on Microsoft Mobile. Full database of codes in your pocket

#### WH-TRIAX

##### **Instacode Interface Program**

- Interface Software to allow seamless intergration with Silca Triax milling machine

#### WH-PROMAST

##### **Promaster Proffesional Masterkeying Program**

- Professional masterkeying program with full range of reports.



# ADVANCED KEYS - OEM

**AUDI** **OEM**



Audi Flip Key  
<2001  
with  
Megamos  
Crypto Transponder

CODE	DESCRIPTION
AKK1	Transponder Flip Key <2001

**AUDI** **OEM**



A3 1997-2003  
A4 1999-2001  
A6 1998-2005  
A8 1994-2003  
TT 1999-2002  
RS4 2001-2002  
3 button remote  
(4D0837231R)

CODE	DESCRIPTION
AKRMI	Transponder Flip Key <2001

**AUDI** **OEM**



2 Button  
Remote

A2 A3 A4  
A6 A8

CODE	DESCRIPTION
AKRM2	Transponder Remote

**CITREON** **OEM**



C3  
Key with  
2 Button  
Remote Control

CODE	DESCRIPTION
AKK246	Transponder Remote

**CITREON** **OEM**



C3  
2002>  
2 Button  
Remote  
Radio frequency

CODE	DESCRIPTION
AKRMIO	Transponder Remote

**CITREON** **OEM**



Citroen C3  
2002>  
2 track blade

CODE	DESCRIPTION
AKK13	Key Blade

**DAEWOO** **OEM**



MATIZ  
Early (to 577030)

CODE	DESCRIPTION
AKK147	Transponder Key

**DAEWOO** **OEM**



LANOS  
Early (to 595888)

CODE	DESCRIPTION
AKK148	Transponder Key

**DAEWOO** **OEM**



NUBIRA  
Early

CODE	DESCRIPTION
AKK149	Transponder Key

**DAEWOO** **OEM**



MATIZ  
Early (577031 on)

CODE	DESCRIPTION
AKK152	Transponder Key

**DAEWOO** **OEM**



LANOS  
Early (595889 on)

CODE	DESCRIPTION
AKK153	Transponder Key

**DAEWOO** **OEM**



MATIZ  
2 Button  
With Remote

CODE	DESCRIPTION
AKK158	Transponder Key

# ADVANCED KEYS - OEM

**FORD** **OEM**



Ford: Focus Flick Key  
Horseshoe  
ID63

CODE	DESCRIPTION
AKK239	Transponder Flick Key

**GM** **OEM**



GM: Various models.  
Horseshoe key  
D series Blade  
No Transponder

CODE	DESCRIPTION
AKK215	Transponder Horseshoe

**GM** **OEM**



GM: Various models  
Horseshoe key  
Z series Blade  
No transponder

CODE	DESCRIPTION
AKK216	Transponder Horseshoe

**HYUNDAI** **OEM**



Accent  
1998>  
Texas fixed key  
4c

CODE	DESCRIPTION
AKK24	Transponder Key

**HYUNDAI** **OEM**



Elantra XD  
Facelift  
04-06  
Transponder Key  
ID46

CODE	DESCRIPTION
AKK227	Transponder Key

**HYUNDAI** **OEM**



Elantra HD  
06>  
Transponder Key  
ID46

CODE	DESCRIPTION
AKK228	Transponder Key

**HYUNDAI** **OEM**



Sonata NF  
05>  
Transponder Key  
ID46

CODE	DESCRIPTION
AKK230	Transponder Key

**HYUNDAI** **OEM**



Tucson  
05>  
Transponder Key  
ID46

CODE	DESCRIPTION
AKK232	Transponder Key

**HYUNDAI** **OEM**



Santa Fe  
06>  
Transponder Key  
ID46.

CODE	DESCRIPTION
AKK233	Transponder Key

**MITSUBISHI** **OEM**



Sonata  
1998>  
Transponder Key  
4C.

CODE	DESCRIPTION
AKK25	Transponder Key

**MITSUBISHI** **OEM**



Colt  
1996>  
Texas fixed  
4C

CODE	DESCRIPTION
AKK32	Transponder Key

**MITSUBISHI** **OEM**



Primera  
1999>  
Transponder Key  
Philips Crypto Red P-11  
ID41.

CODE	DESCRIPTION
AKK85	Transponder Key

# ADVANCED KEYS - OEM

**NISSAN** **OEM**

Primera  
Micra  
Almera  
1998  
Transponder Key  
Phillips Crypto Red  
ID41



CODE	DESCRIPTION
AKK86	Transponder Key

**NISSAN** **OEM**

Micra  
Cabstar  
2000>  
Transponder Key  
Texas Crypto Blue  
4D60



CODE	DESCRIPTION
AKK87	Transponder Key

**NISSAN** **OEM**

Primera  
Almera  
1999>  
Transponder Key  
Texas Crypto Blue  
4D60



CODE	DESCRIPTION
AKK88	Transponder Key

**OPEL** **OEM**

General Motors:  
Vectra C/Signum  
Flick Key  
2 button remote  
control  
(Z series blade)



CODE	DESCRIPTION
AKK196	Transponder Flip Key

**OPEL** **OEM**

GM Corsa C/Moriva  
Horseshoe  
(Z series blade)



CODE	DESCRIPTION
AKK210	Transponder Horseshoe

**PEUGEOT** **OEM**

Peugeot: Partner  
2000>  
Transponder Key  
ID46.

Phillips  
Crypto



CODE	DESCRIPTION
AKK43	Transponder Key

**PEUGEOT** **OEM**

406  
1997>  
Blade External  
4 track.



CODE	DESCRIPTION
AKK47	Key Blade

**PEUGEOT** **OEM**

Peugeot:  
106/206/306 1995>  
Renault:  
various models 1995>



CODE	DESCRIPTION
AKK51	Key Blade

**PEUGEOT** **OEM**

307  
2001>  
Internal 2 track blade



CODE	DESCRIPTION
AKK54	Transponder Key

**PEUGEOT** **OEM**

307  
2001>  
Transponder Key  
ID46.



CODE	DESCRIPTION
AKK55	Key Blade

**PEUGEOT** **OEM**

307  
2005 >  
Flick Key  
With  
Remote Control



CODE	DESCRIPTION
AKK200	Transponder Flip Key

**RENAULT** **OEM**

Various models  
1995>  
Key Blade



CODE	DESCRIPTION
AKK57	Key Blade

# KEYBLANKS

**TOYOTA** **OEM**



Transponder Key  
Toyo-15 (TOY43)  
ID67

CODE	DESCRIPTION
AKK223	Transponder Key

**VW** **OEM**

Polo/Sharan  
Golf/Passat  
2001>

Seat: Alhambra  
2000>

Square 2 button  
remote control.



CODE	DESCRIPTION
AKRM25	Transponder Remote

**VW** **OEM**

VW vehicles  
<2001  
Flick Key with  
Horseshoe  
Megamos Crypto  
(round type).



CODE	DESCRIPTION
AKK145	Transponder Flip Key

**VW** **OEM**

VW vehicles  
2001>,  
Flick Key with  
Horseshoe  
Megamos Crypto  
ID48.  
(square type)



CODE	DESCRIPTION
AKK146	Transponder Flip Key

**IVECO** **OEM**



CODE	DESCRIPTION
AKK27	Transponder Key

**TOYOTA**

TOY48  
Remote  
3 Button



CODE	DESCRIPTION
EKB-TOYO303S	Key shell 3 Button

**FORD**

C-Max



CODE	DESCRIPTION
EKR-FOCM	Remote Shell

**FORD**

Focus  
433MHZ



CODE	DESCRIPTION
EKCR-FO24P	Remote Horseshoe

**OPEL**

HUI00  
T12



CODE	DESCRIPTION
EKBT-OP1140T12	Transponder Blank

**MAZDA**

Mazda 8C



CODE	DESCRIPTION
EKBT-MAZ11DP8C	Transponder Blank

**HYUNDAI**

Elantra 46



CODE	DESCRIPTION
EKBT-HY4P46	Transponder Blank

**HYUNDAI**

Atos 46



CODE	DESCRIPTION
EKBT-HY546	Transponder Blank

# KEYBLANKS

**AUDI**



Without Transponder

CODE	DESCRIPTION
EKB-HUHAA.TLV	Audi Remote

**BMW**



New Style HU92

CODE	DESCRIPTION
EKB-HU92R.P3	BMW 3 Button Remote

**BMW**



Old Style HU58

CODE	DESCRIPTION
EKB-HU58.P3	BMW Remote Keyblank

**CHRYSLER**



X-Trail  
Almera

CODE	DESCRIPTION
EKB-CHR.I5P	Chrysler 4D Transponder

**FIAT**



FIAT Transponder Blank

CODE	DESCRIPTION
EKB-FI13.P	Fiat Transponder Blank

**HONDA**



Honda Transponder 2.4

CODE	DESCRIPTION
EKB-HON66.P2	Honda 2 Button

**HONDA**



Honda Transponder 2.4

CODE	DESCRIPTION
EKBS-HON66P3	Honda 3 Button

**HYUNDAI**



Original 46

CODE	DESCRIPTION
EKB-HY6DP146	Hyundai Transponder

**MITSUBISHI**



MITIIR 2 Button Remote

CODE	DESCRIPTION
EKBS-MIT11R.P2	Mitsubishi 2 Button

**NISSAN**



X-Trail  
Almera  
46

CODE	DESCRIPTION
EKBT-DAT15-46AM	Transponder Key

**NISSAN**



Tiida

CODE	DESCRIPTION
EKBT-DAT15TIIDA	Transponder Key

**NISSAN**



Pathfinder  
4D 60

CODE	DESCR.
EKBT-DAT15P4D-60	Transponder Key

# KEYBLANKS

**NISSAN**

NSN14  
X-Trail  
Almera  
4D 60



CODE	DESCR
EKBT-DAT15P24D60	Transponder Key

**NISSAN**

Teana  
Tiida



CODE	DESCRIPTION
EKBT-DAT15P	Nissan Transponder

**NISSAN**

Micra  
Almera



CODE	DESCRIPTION
EKB-NASHELL	2 Button Remote Shell

**OPEL**

Opel  
Chevrolet  
GM Astra



CODE	DESCRIPTION
EKB-OP11P2	Remote 2- Button

**OPEL**

Deep Horse Shoe  
OP-S  
HU46



CODE	DESCRIPTION
EKB-OPSP	Opel Remote Blade

**OPEL**

HU100BT12  
2004+  
Meriva



CODE	DESCRIPTION
EKB-OP11HS	Opel Remote Blade

**OPEL**



CODE	DESCRIPTION
EKB-OPS	Opel Remote Key Head

**OPEL**

Corsa



CODE	DESCRIPTION
EKB-OPS1	Opel Remote Blade

**OPEL**

Deep Horse Shoe  
OP-D  
YM28



CODE	DESCRIPTION
EKB-OPD1	Opel Remote Blade

**OPEL**

Left Side  
NEW



CODE	DESCRIPTION
EKB-OPS old	Chev Transponder

**OPEL**



CODE	DESCRIPTION
EKR-OPEL2	Opel 2 Button Shell

**SUBARU**

Legacy  
Outback



CODE	DESCRIPTION
EKB-SUB2P	Transponder 4D

# KEYBLANKS

SUZUKI



CODE	DESCRIPTION
EKB-SUZU14P	Suzuki Transponder

TOYOTA



2 Button Key Shell

Lexus

CODE	DESCRIPTION
EKB5-TOYO36P2	Remote Key Blank

TOYOTA



2 Button Key Shell

TOY47

CODE	DESCRIPTION
EKB-TOYO19.P2	Toyota 2 Button

TOYOTA



Toyota Master Key  
4C  
New style

CODE	DESCRIPTION
EKBT-TOYO15M-4C	Transponder Key

TOYOTA



3 Button Key Shell

TOY47

CODE	DESCRIPTION
EKB-TOYO19P3G	Toyota 3 Button

TOYOTA



2 Button Key Shell

TOY43

CODE	DESCRIPTION
EKB-TOYO15P2S	Toyota 2 Button

FORD



Mondeo  
4D 60

CODE	DESCRIPTION
EKBT-FO6.4D	Transponder Ford

FORD



Blank Mondeo

CODE	DESCRIPTION
EKB-FO6.PM	Transponder Ford

FORD



C-Max

CODE	DESCRIPTION
EKB-FOCM	Remote Ford Shell

RENAULT



Kangoo Blank

CODE	DESCRIPTION
EKB-VA34P	Transponder Renault

FORD



C-Max

CODE	DESCRIPTION
EKB-FO24P	Remote Ford Head

FORD



C-Max  
Blank

CODE	DESCRIPTION
EKB5-FO2424P	Transponder Key

# KEYBLANKS

CITROEN



CODE	DESCRIPTION
EKB-NE36P2	Key Blank 2 Button

CITROEN

Xsara  
Picasso



CODE	DESCRIPTION
EKR-CITROEN	Remote Case

CITROEN



CODE	DESCRIPTION
EKS-CIT3	Key shell 3 Button

CITROEN

Citroen 46



CODE	DESCRIPTION
EKBT-SIXP46	Transponder Blank

HYUNDAI

Right Side  
New Style



CODE	DESCRIPTION
EKB-HY6DP	Transponder Blank

HYUNDAI

Left Side  
New Style



CODE	DESCRIPTION
EKB-HY9P	Transponder Blank

FORD

Mondeo



CODE	DESCRIPTION
EKB-FO6P	Remote Key Head

CITROEN  
PEUGEOT



CODE	DESCRIPTION
EKBB-HUHCAP	Key Blade

RENAULT  
PEUGEOT



CODE	DESCRIPTION
EKBB-REN-PEUG	Key Blade

RENAULT

Clio



CODE	DESCRIPTION
EKBS-RENCLIO-2	Key Blank 2 Button

RENAULT

Kangoo



CODE	DESCRIPTION
EKBS-NE38P1	Ket Shell 1 Button

NISSAN



CODE	DESCRIPTION
EKB-DAT15P	Transponder Key Blank



# REMOTES



- Keelog Rolling Code System
- ICASA Approved
- Battery low indication
- 10 to 100m line of site communication



CODE	DESCRIPTION	BARCODE
ET753	Remote ET Rolling Code 1 button	6009695289121
ET757	Remote ET Rolling Code 2 button	6009695289138
ET763	Remote ET Rolling Code 4 button	6009695289145
ET764	Remote ET Rolling Code 6 button	6009695289183



- LTX Learning Remotes
- Copies most industry standard formats
- Accurate data reproduction
- Individual coding per button



CODE	DESCRIPTION	BARCODE
ETLTX404-1	Remote ET universal learning 1 button	6009695289176
ETLTX404-4	Remote ET universal learning 4 button	6009695289169



CODE	DESCRIPTION
ET728	Rolling Code Receiver 434MZH



380 MHz  
404 MHz  
434 MHz

CODE	DESCRIPTION
ET956	LTX Frequency Tester



380 MHz  
404 MHz  
434 MHz

CODE	DESCRIPTION
ET895	Receiver TX Tester